

JEE 2023 Session-1 24th Jan to 1st Feb 2023

| | |
|----------------|-------------------|
| Application No | |
| Candidate Name | |
| Roll No | |
| Test Date | |
| Test Time | 3:00 PM - 6:00 PM |
| Subject | B TECH |

Section : Physics Section A

Q.1 The escape velocities of two planets A and B are in the ratio 1 : 2. If the ratio of their radii respectively is 1 : 3, then the ratio of acceleration due to gravity of planet A to the acceleration of gravity of planet B will be :

- Options**
1. $\frac{3}{2}$
 2. $\frac{2}{3}$
 3. $\frac{3}{4}$
 4. $\frac{4}{3}$

Question Type : MCQ

Question ID : 7155051174

Option 1 ID : 7155053526

Option 2 ID : 7155053523

Option 3 ID : 7155053525

Option 4 ID : 7155053524

Status : Answered

Chosen Option : 1

Q.2 Equivalent resistance between the adjacent corners of a regular n-sided polygon of uniform wire of resistance R would be :

- Options**
1. $\frac{n^2 R}{n-1}$
 2. $\frac{(n-1)R}{n}$
 3. $\frac{(n-1)R}{(2n-1)}$
 4. $\frac{(n-1)R}{n^2}$

Question Type : MCQ

Question ID : 7155051181

Option 1 ID : 7155053553

Option 2 ID : 7155053551

Option 3 ID : 7155053554

Option 4 ID : 7155053552

Status : Answered

Chosen Option : 4

Q.3 Two objects A and B are placed at 15 cm and 25 cm from the pole in front of a concave mirror having radius of curvature 40 cm. The distance between images formed by the mirror is _____.

- Options**
1. 100 cm
 2. 160 cm
 3. 40 cm
 4. 60 cm

Question Type : MCQ

Question ID : 7155051186

Option 1 ID : 7155053573

Option 2 ID : 7155053574

Option 3 ID : 7155053572

Option 4 ID : 7155053571

Status : Answered

Chosen Option : 3

Q.4 In an amplitude modulation, a modulating signal having amplitude of X V is superimposed with a carrier signal of amplitude Y V in first case. Then, in second case, the same modulating signal is superimposed with different carrier signal of amplitude 2Y V. The ratio of modulation index in the two cases respectively will be :

- Options**
1. 2 : 1
 2. 4 : 1
 3. 1 : 1
 4. 1 : 2

Question Type : MCQ

Question ID : 7155051190

Option 1 ID : 7155053588

Option 2 ID : 7155053590

Option 3 ID : 7155053589

Option 4 ID : 7155053587

Status : Answered

Chosen Option : 4

Q.5 Figures (a), (b), (c) and (d) show variation of force with time.

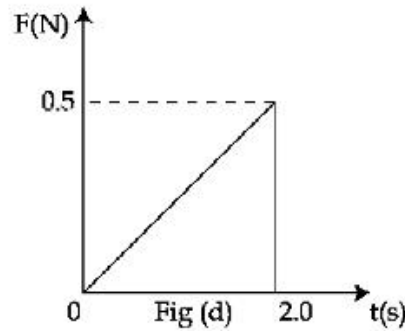
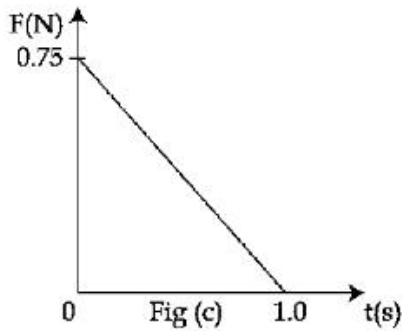
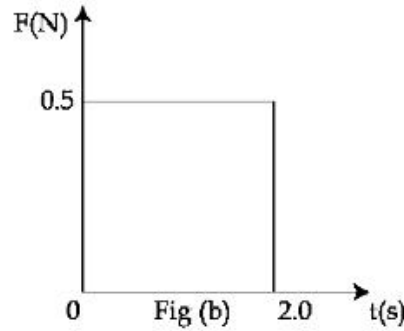
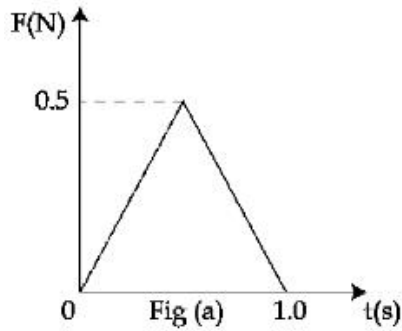

The impulse is highest in figure.

- Options
1. Fig (b)
 2. Fig (a)
 3. Fig (c)
 4. Fig (d)

Question Type : MCQ

Question ID : 7155051172

Option 1 ID : 7155053516

Option 2 ID : 7155053515

Option 3 ID : 7155053517

Option 4 ID : 7155053518

Status : Answered

Chosen Option : 2

Q.6 Choose the correct statement about Zener diode :

Options

1. It works as a voltage regulator in both forward and reverse bias.

2. It works as a voltage regulator in forward bias and behaves like simple pn junction diode in reverse bias.

3. It works as a voltage regulator only in forward bias.

4. It works as a voltage regulator in reverse bias and behaves like simple pn junction diode in forward bias.

Question Type : MCQ

Question ID : 7155051189

Option 1 ID : 7155053585

Option 2 ID : 7155053583

Option 3 ID : 7155053586

Option 4 ID : 7155053584

Status : Answered

Chosen Option : 4

Q.7 Given below are two statements : One is labelled as **Assertion A** and the other is labelled as **Reason R**.

Assertion A : Two metallic spheres are charged to the same potential. One of them is hollow and another is solid, and both have the same radii. Solid sphere will have lower charge than the hollow one.

Reason R : Capacitance of metallic spheres depend on the radii of spheres.

In the light of the above statements, choose the **correct** answer from the options given below.

- Options**
1. **A is false but R is true**
 2. **A is true but R is false**
 3. **Both A and R are true and R is the correct explanation of A**
 4. **Both A and R are true but R is not the correct explanation of A**

Question Type : **MCQ**

Question ID : **7155051180**

Option 1 ID : **7155053550**

Option 2 ID : **7155053549**

Option 3 ID : **7155053547**

Option 4 ID : **7155053548**

Status : **Answered**

Chosen Option : **3**

Q.8 Choose the correct length (L) versus square of time period (T^2) graph for a simple pendulum executing simple harmonic motion.

Options

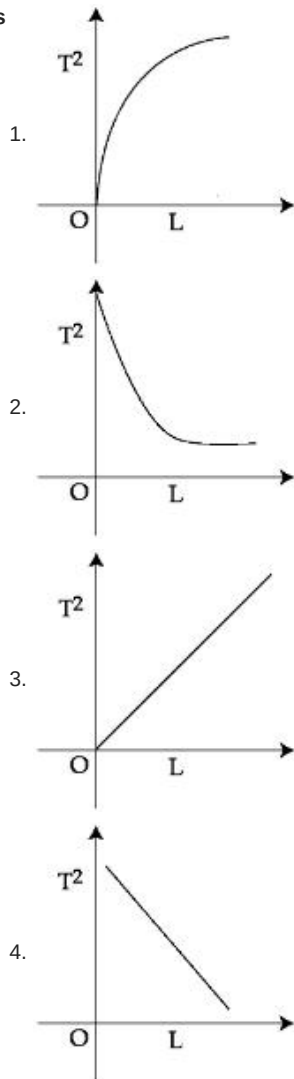

Question Type : MCQ

Question ID : 7155051178

Option 1 ID : 7155053539

Option 2 ID : 7155053540

Option 3 ID : 7155053542

Option 4 ID : 7155053541

Status : Answered

Chosen Option : 1

Q.9 The ratio of average electric energy density and total average energy density of electromagnetic wave is :

- Options
1. $\frac{1}{2}$
 2. 3
 3. 2
 4. 1

Question Type : MCQ

Question ID : 7155051185

Option 1 ID : 7155053569

Option 2 ID : 7155053570

Option 3 ID : 7155053568

Option 4 ID : 7155053567

Status : Answered

Chosen Option : 4

Q.10 For three low density gases A, B, C pressure versus temperature graphs are plotted while keeping them at constant volume, as shown in the figure.

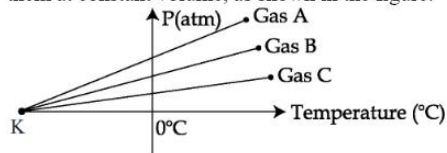

The temperature corresponding to the point 'K' is :

- Options**
1. -100°C
 2. -273°C
 3. -40°C
 4. -373°C

Question Type : MCQ

Question ID : 7155051177

Option 1 ID : 7155053535

Option 2 ID : 7155053537

Option 3 ID : 7155053536

Option 4 ID : 7155053538

Status : Answered

Chosen Option : 1

Q.11 An electron of a hydrogen like atom, having $Z = 4$, jumps from 4th energy state to 2nd energy state.

The energy released in this process, will be :

(Given $R_{ch} = 13.6 \text{ eV}$)

Where R = Rydberg constant

c = Speed of light in vacuum

h = Planck's constant

- Options**
1. 10.5 eV
 2. 40.8 eV
 3. 13.6 eV
 4. 3.4 eV

Question Type : MCQ

Question ID : 7155051188

Option 1 ID : 7155053581

Option 2 ID : 7155053580

Option 3 ID : 7155053579

Option 4 ID : 7155053582

Status : Answered

Chosen Option : 4

Q.12 Given below are two statements : One is labelled as **Assertion A** and the other is labelled as **Reason R**.

Assertion A : For measuring the potential difference across a resistance of 600Ω , the voltmeter with resistance 1000Ω will be preferred over voltmeter with resistance 4000Ω .

Reason R : Voltmeter with higher resistance will draw smaller current than voltmeter with lower resistance.

In the light of the above statements, choose the **most appropriate** answer from the options given below.

Options 1. **A** is correct but **R** is not correct

2.

Both **A** and **R** are correct but **R** is **not** the correct explanation of **A**

3. **A** is not correct but **R** is correct

4.

Both **A** and **R** are correct and **R** is the correct explanation of **A**

Question Type : **MCQ**

Question ID : **7155051183**

Option 1 ID : **7155053561**

Option 2 ID : **7155053560**

Option 3 ID : **7155053562**

Option 4 ID : **7155053559**

Status : **Answered**

Chosen Option : **4**

Q.13 If the velocity of light c , universal gravitational constant G and Planck's constant h are chosen as fundamental quantities. The dimensions of mass in the new system is :

Options 1. $[h^{-1/2} c^{1/2} G^{1/2}]$

2. $[h^{1/2} c^{-1/2} G^1]$

3. $[h^{1/2} c^{1/2} G^{-1/2}]$

4. $[h^1 c^1 G^{-1}]$

Question Type : **MCQ**

Question ID : **7155051179**

Option 1 ID : **7155053546**

Option 2 ID : **7155053545**

Option 3 ID : **7155053544**

Option 4 ID : **7155053543**

Status : **Answered**

Chosen Option : **1**

- Q.14** As shown in the figure, a long straight conductor with semicircular arc of radius $\frac{\pi}{10}$ m is carrying current $I = 3\text{A}$. The magnitude of the magnetic field, at the center O of the arc is :
(The permeability of the vacuum = $4\pi \times 10^{-7} \text{NA}^{-2}$)



- Options**
1. $6\mu\text{T}$
 2. $3\mu\text{T}$
 3. $4\mu\text{T}$
 4. $1\mu\text{T}$

Question Type : MCQ

Question ID : 7155051182

Option 1 ID : 7155053558

Option 2 ID : 7155053556

Option 3 ID : 7155053557

Option 4 ID : 7155053555

Status : Answered

Chosen Option : 1

- Q.15** The threshold frequency of a metal is f_0 . When the light of frequency $2f_0$ is incident on the metal plate, the maximum velocity of photoelectrons is v_1 . When the frequency of incident radiation is increased to $5f_0$, the maximum velocity of photoelectrons emitted is v_2 . The ratio of v_1 to v_2 is :

- Options**
1. $\frac{v_1}{v_2} = \frac{1}{16}$
 2. $\frac{v_1}{v_2} = \frac{1}{8}$
 3. $\frac{v_1}{v_2} = \frac{1}{2}$
 4. $\frac{v_1}{v_2} = \frac{1}{4}$

Question Type : MCQ

Question ID : 7155051187

Option 1 ID : 7155053578

Option 2 ID : 7155053577

Option 3 ID : 7155053576

Option 4 ID : 7155053575

Status : Answered

Chosen Option : 4

- Q.16** As shown in the figure a block of mass 10 kg lying on a horizontal surface is pulled by a force F acting at an angle 30° , with horizontal. For $\mu_s=0.25$, the block will just start to move for the value of F : [Given $g = 10 \text{ ms}^{-2}$]

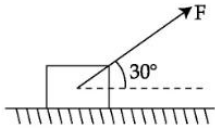

- Options**
1. 20 N
 2. 33.3 N
 3. 25.2 N
 4. 35.7 N

Question Type : MCQ

Question ID : 7155051173

Option 1 ID : 7155053520

Option 2 ID : 7155053519

Option 3 ID : 7155053521

Option 4 ID : 7155053522

Status : Answered

Chosen Option : 3

- Q.17** For a body projected at an angle with the horizontal from the ground, choose the correct statement.

- Options**
1. The Kinetic Energy (K.E.) is zero at the highest point of projectile motion.
 2. The vertical component of momentum is maximum at the highest point.
 3. The horizontal component of velocity is zero at the highest point.
 4. Gravitational potential energy is maximum at the highest point.

Question Type : MCQ

Question ID : 7155051171

Option 1 ID : 7155053511

Option 2 ID : 7155053514

Option 3 ID : 7155053512

Option 4 ID : 7155053513

Status : Answered

Chosen Option : 1

- Q.18** The Young's modulus of a steel wire of length 6 m and cross-sectional area 3 mm^2 , is $2 \times 10^{11} \text{ N/m}^2$. The wire is suspended from its support on a given planet. A block of mass 4 kg is attached to the free end of the wire. The acceleration due to gravity on the planet is $\frac{1}{4}$ of its value on the earth. The elongation of wire is (Take g on the earth = 10 m/s^2) :

- Options**
1. 0.1 mm
 2. 1 mm
 3. 0.1 cm
 4. 1 cm

Question Type : MCQ

Question ID : 7155051175

Option 1 ID : 7155053527

Option 2 ID : 7155053529

Option 3 ID : 7155053528

Option 4 ID : 7155053530

Status : Answered

Chosen Option : 1

Q.19 A Carnot engine operating between two reservoirs has efficiency $\frac{1}{3}$. When the temperature of cold reservoir raised by x , its efficiency decreases to $\frac{1}{6}$. The value of x , if the temperature of hot reservoir is 99°C , will be :

- Options**
1. 33 K
 2. 16.5 K
 3. 66 K
 4. 62 K

Question Type : MCQ
 Question ID : 7155051176
 Option 1 ID : 7155053532
 Option 2 ID : 7155053531
 Option 3 ID : 7155053534
 Option 4 ID : 7155053533
 Status : Answered
 Chosen Option : 1

Q.20 A coil is placed in magnetic field such that plane of coil is perpendicular to the direction of magnetic field. The magnetic flux through a coil can be changed :

- A. By changing the magnitude of the magnetic field within the coil.
- B. By changing the area of coil within the magnetic field.
- C. By changing the angle between the direction of magnetic field and the plane of the coil.
- D. By reversing the magnetic field direction abruptly without changing its magnitude.

Choose the most appropriate answer from the options given below :

- Options**
1. A, B and C only
 2. A and B only
 3. A, B and D only
 4. A and C only

Question Type : MCQ
 Question ID : 7155051184
 Option 1 ID : 7155053565
 Option 2 ID : 7155053563
 Option 3 ID : 7155053566
 Option 4 ID : 7155053564
 Status : Answered
 Chosen Option : 1

Section : Physics Section B

Q.21 A force $F = (5 + 3y^2)$ acts on a particle in the y -direction, where F is in newton and y is in meter. The work done by the force during a displacement from $y = 2\text{m}$ to $y = 5\text{m}$ is _____ J.

Given 21
 Answer :

Question Type : SA
 Question ID : 7155051192
 Status : Answered

Q.22 For a train engine moving with speed of 20 ms^{-1} , the driver must apply brakes at a distance of 500 m before the station for the train to come to rest at the station. If the brakes were applied at half of this distance, the train engine would cross the station with speed $\sqrt{x}\text{ ms}^{-1}$. The value of x is

_____.
 (Assuming same retardation is produced by brakes)

Given 2
 Answer :

Question Type : SA
 Question ID : 7155051191
 Status : Answered

- Q.23** A cubical volume is bounded by the surfaces $x = 0, x = a, y = 0, y = a, z = 0, z = a$. The electric field in the region is given by $\vec{E} = E_0 x \hat{i}$. Where $E_0 = 4 \times 10^4 \text{ NC}^{-1}\text{m}^{-1}$. If $a = 2 \text{ cm}$, the charge contained in the cubical volume is $Q \times 10^{-14} \text{ C}$. The value of Q is _____.
Take $\epsilon_0 = 9 \times 10^{-12} \text{ C}^2/\text{Nm}^2$

Given --
Answer :

Question Type : SA
Question ID : 7155051196
Status : Not Attempted and Marked For Review

- Q.24** In the given circuit, the value of $\left| \frac{I_1 + I_3}{I_2} \right|$ is _____

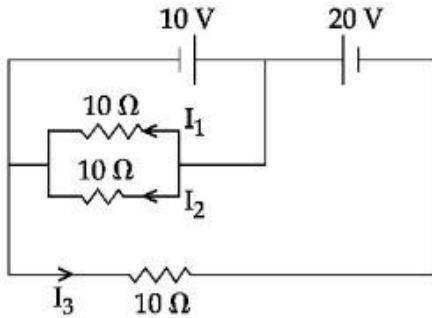

Given 2
Answer :

Question Type : SA
Question ID : 7155051197
Status : Answered

- Q.25** A square shaped coil of area 70 cm^2 having 600 turns rotates in a magnetic field of 0.4 wbm^{-2} , about an axis which is parallel to one of the side of the coil and perpendicular to the direction of field. If the coil completes 500 revolution in a minute, the instantaneous emf when the plane of the coil is inclined at 60° with the field, will be _____ V. (Take $\pi = \frac{22}{7}$)

Given 44
Answer :

Question Type : SA
Question ID : 7155051198
Status : Answered

- Q.26** A block is fastened to a horizontal spring. The block is pulled to a distance $x = 10 \text{ cm}$ from its equilibrium position (at $x = 0$) on a frictionless surface from rest. The energy of the block at $x = 5 \text{ cm}$ is 0.25 J . The spring constant of the spring is _____ Nm^{-1} .

Given --
Answer :

Question Type : SA
Question ID : 7155051195
Status : Not Answered

- Q.27** As shown in the figure, in Young's double slit experiment, a thin plate of thickness $t = 10\mu\text{m}$ and refractive index $\mu = 1.2$ is inserted in front of slit S_1 . The experiment is conducted in air ($\mu = 1$) and uses a monochromatic light of wavelength $\lambda = 500\text{ nm}$. Due to the insertion of the plate, central maxima is shifted by a distance of $x\beta_0$. β_0 is the fringe-width before the insertion of the plate. The value of the x is _____.

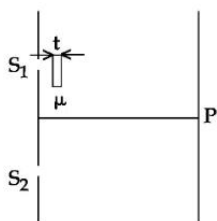

Given --
Answer :

Question Type : SA
Question ID : 7155051199
Status : Not Answered

- Q.28** Moment of inertia of a disc of mass M and radius 'R' about any of its diameter is $\frac{MR^2}{4}$. The moment of inertia of this disc about an axis normal to the disc and passing through a point on its edge will be, $\frac{x}{2}MR^2$. The value of x is _____.

Given --
Answer :

Question Type : SA
Question ID : 7155051193
Status : Not Answered

- Q.29** The surface of water in a water tank of cross section area 750 cm^2 on the top of a house is h m above the tap level. The speed of water coming out through the tap of cross section area 500 mm^2 is 30 cm/s . At that instant, $\frac{dh}{dt}$ is $x \times 10^{-3}\text{ m/s}$. The value of x will be _____.

Given --
Answer :

Question Type : SA
Question ID : 7155051194
Status : Not Answered

- Q.30** Nucleus A having $Z = 17$ and equal number of protons and neutrons has 1.2 MeV binding energy per nucleon. Another nucleus B of $Z = 12$ has total 26 nucleons and 1.8 MeV binding energy per nucleons. The difference of binding energy of B and A will be _____ MeV.

Given **45.6**
Answer :

Question Type : SA
Question ID : 7155051200
Status : Answered

Section : Chemistry Section A

Q.31 Given below are two statements : one is labelled as **Assertion (A)** and the other is labelled as **Reason (R)**.

Assertion (A) : Cu^{2+} in water is more stable than Cu^+ .

Reason (R) : Enthalpy of hydration for Cu^{2+} is much less than that of Cu^+ .

In the light of the above statements, choose the **correct** answer from the options given below :

Options 1. **(A)** is not correct but **(R)** is correct

2.

Both **(A)** and **(R)** are correct and **(R)** is the correct explanation of **(A)**

3. **(A)** is correct but **(R)** is not correct

4.

Both **(A)** and **(R)** are correct but **(R)** is **not** the correct explanation of **(A)**

Question Type : **MCQ**

Question ID : **7155051209**

Option 1 ID : **7155053636**

Option 2 ID : **7155053633**

Option 3 ID : **7155053635**

Option 4 ID : **7155053634**

Status : **Answered**

Chosen Option : **2**

Q.32 The effect of addition of helium gas to the following reaction in equilibrium state, is :
 $\text{PCl}_5(\text{g}) \rightleftharpoons \text{PCl}_3(\text{g}) + \text{Cl}_2(\text{g})$

Options 1.

the equilibrium will go backward due to suppression of dissociation of PCl_5 .

2.

the equilibrium will shift in the forward direction and more of Cl_2 and PCl_3 gases will be produced.

3. **helium will deactivate PCl_5 and reaction will stop.**

4. **addition of helium will not affect the equilibrium.**

Question Type : **MCQ**

Question ID : **7155051203**

Option 1 ID : **7155053610**

Option 2 ID : **7155053611**

Option 3 ID : **7155053612**

Option 4 ID : **7155053609**

Status : **Answered**

Chosen Option : **4**

- Q.33** In figure, a straight line is given for Freundlich Adsorption ($y = 3x + 2.505$). The value of $\frac{1}{n}$ and $\log K$ are respectively.

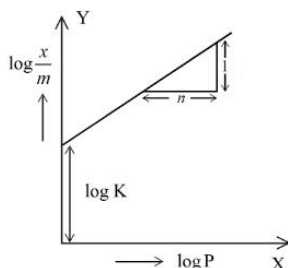

Options 1. 0.3 and $\log 2.505$

2. 3 and 2.505

3. 3 and 0.7033

4. 0.3 and 0.7033

Question Type : MCQ

Question ID : 7155051204

Option 1 ID : 7155053614

Option 2 ID : 7155053613

Option 3 ID : 7155053616

Option 4 ID : 7155053615

Status : Answered

Chosen Option : 2

- Q.34** The structures of major products A, B and C in the following reaction are sequence.

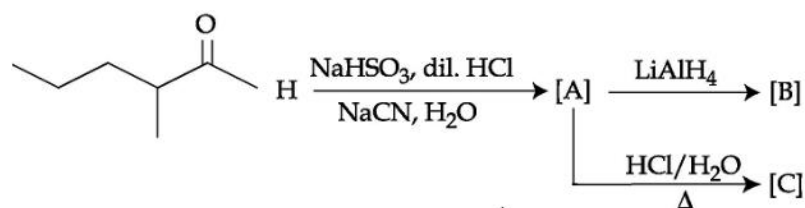

Options 1.

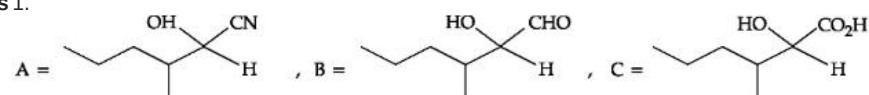

2.

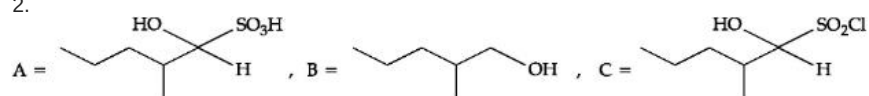

3.

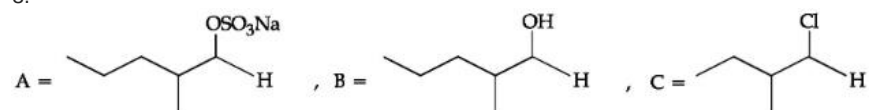

4.

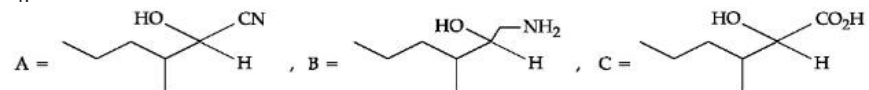

Question Type : MCQ

Question ID : 7155051216

Option 1 ID : 7155053664

Option 2 ID : 7155053661

Option 3 ID : 7155053663

Option 4 ID : 7155053662

Status : Answered

Chosen Option : 1

Q.35 Given below are two statements : one is labelled as **Assertion (A)** and the other is labelled as

Reason (R).

Assertion (A) : Gypsum is used for making fireproof wall boards.

Reason (R) : Gypsum is unstable at high temperatures.

In the light of the above statements, choose the **correct** answer from the options given below :

Options 1. **(A)** is not correct but **(R)** is correct

2.

Both **(A)** and **(R)** are correct but **(R)** is not the correct explanation of **(A)**

3.

Both **(A)** and **(R)** are correct and **(R)** is the correct explanation of **(A)**

4. **(A)** is correct but **(R)** is not correct

Question Type : **MCQ**

Question ID : **7155051207**

Option 1 ID : **7155053628**

Option 2 ID : **7155053626**

Option 3 ID : **7155053625**

Option 4 ID : **7155053627**

Status : **Answered**

Chosen Option : **2**

Q.36 Which element is not present in Nessler's reagent ?

Options 1. Mercury

2. Iodine

3. Potassium

4. Oxygen

Question Type : **MCQ**

Question ID : **7155051218**

Option 1 ID : **7155053672**

Option 2 ID : **7155053671**

Option 3 ID : **7155053669**

Option 4 ID : **7155053670**

Status : **Answered**

Chosen Option : **4**

Q.37 The starting material for convenient preparation of deuterated hydrogen peroxide (D_2O_2) in laboratory is :

Options 1. $K_2S_2O_8$

2. BaO

3. BaO₂

4. 2-ethylanthraquinol

Question Type : **MCQ**

Question ID : **7155051206**

Option 1 ID : **7155053623**

Option 2 ID : **7155053621**

Option 3 ID : **7155053622**

Option 4 ID : **7155053624**

Status : **Answered**

Chosen Option : **2**

Q.38 Which one of the following sets of ions represents a collection of isoelectronic species ?
(Given : Atomic Number : F : 9, Cl : 17, Na = 11, Mg = 12, Al = 13, K = 19, Ca = 20, Sc = 21)

- Options
1. N^{3-} , O^{2-} , F^- , S^{2-}
 2. Ba^{2+} , Sr^{2+} , K^+ , Ca^{2+}
 3. Li^+ , Na^+ , Mg^{2+} , Ca^{2+}
 4. K^+ , Cl^- , Ca^{2+} , Sc^{3+}

Question Type : MCQ
Question ID : 7155051201
Option 1 ID : 7155053601
Option 2 ID : 7155053604
Option 3 ID : 7155053603
Option 4 ID : 7155053602
Status : Answered
Chosen Option : 1

Q.39 Given below are two statements :

Statement I : Sulphanilic acid gives esterification test for carboxyl group.

Statement II : Sulphanilic acid gives red colour in Lassaigne's test for extra element detection.

In the light of the above statements, choose the **most appropriate** answer from the options given below :

- Options
1. **Statement I** is incorrect but **Statement II** is correct
 2. Both **Statement I** and **Statement II** are correct
 3. Both **Statement I** and **Statement II** are incorrect
 4. **Statement I** is correct but **Statement II** is incorrect

Question Type : MCQ
Question ID : 7155051212
Option 1 ID : 7155053648
Option 2 ID : 7155053645
Option 3 ID : 7155053646
Option 4 ID : 7155053647
Status : Answered
Chosen Option : 2

Q.40 Given below are two statements : one is labelled as **Assertion (A)** and the other is labelled as **Reason (R)**.

Assertion (A) : An aqueous solution of KOH when used for volumetric analysis, its concentration should be checked before the use.

Reason (R) : On aging, KOH solution absorbs atmospheric CO_2 .

In the light of the above statements, choose the **correct** answer from the options given below :

- Options
1. Both **(A)** and **(R)** are correct but **(R)** is **not** the correct explanation of **(A)**
 2. Both **(A)** and **(R)** are correct and **(R)** is the correct explanation of **(A)**
 3. **(A)** is correct but **(R)** is not correct
 4. **(A)** is not correct but **(R)** is correct

Question Type : MCQ
Question ID : 7155051220
Option 1 ID : 7155053678
Option 2 ID : 7155053677
Option 3 ID : 7155053679
Option 4 ID : 7155053680
Status : Answered
Chosen Option : 1

Q.41 The graph which represents the following reaction is :

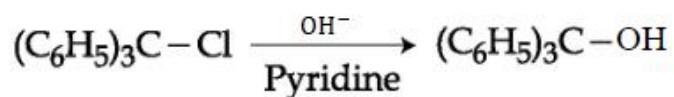

Options

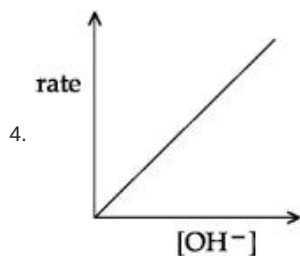
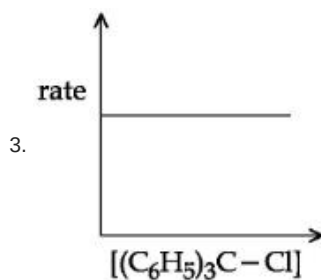
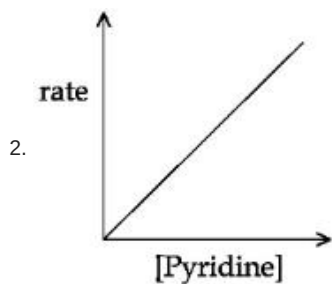
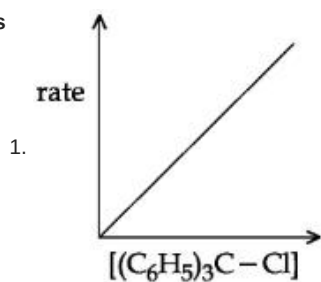

Question Type : MCQ

Question ID : 7155051214

Option 1 ID : 7155053653

Option 2 ID : 7155053654

Option 3 ID : 7155053656

Option 4 ID : 7155053655

Status : Answered

Chosen Option : 1

Q.42 O – O bond length in H_2O_2 is $\underline{\text{X}}$ than the O – O bond length in F_2O_2 . The O – H bond length in H_2O_2 is $\underline{\text{Y}}$ than that of the O – F bond in F_2O_2 .

Choose the correct option for $\underline{\text{X}}$ and $\underline{\text{Y}}$ from those given below :

- Options**
1. $\underline{\text{X}}$ - longer, $\underline{\text{Y}}$ - longer
 2. $\underline{\text{X}}$ - shorter, $\underline{\text{Y}}$ - shorter
 3. $\underline{\text{X}}$ - shorter, $\underline{\text{Y}}$ - longer
 4. $\underline{\text{X}}$ - longer, $\underline{\text{Y}}$ - shorter

Question Type : MCQ

Question ID : 7155051202

Option 1 ID : 7155053605

Option 2 ID : 7155053606

Option 3 ID : 7155053608

Option 4 ID : 7155053607

Status : Answered

Chosen Option : 2

Q.43 In a reaction,

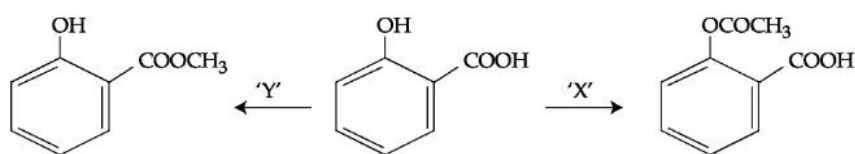

reagents 'X' and 'Y' respectively are :

- Options**
1. $\text{CH}_3\text{OH}/\text{H}^+$, Δ and $(\text{CH}_3\text{CO})_2\text{O}/\text{H}^+$
 2. $\text{CH}_3\text{OH}/\text{H}^+$, Δ and $\text{CH}_3\text{OH}/\text{H}^+$, Δ
 3. $(\text{CH}_3\text{CO})_2\text{O}/\text{H}^+$ and $(\text{CH}_3\text{CO})_2\text{O}/\text{H}^+$
 4. $(\text{CH}_3\text{CO})_2\text{O}/\text{H}^+$ and $\text{CH}_3\text{OH}/\text{H}^+$, Δ

Question Type : MCQ

Question ID : 7155051215

Option 1 ID : 7155053657

Option 2 ID : 7155053659

Option 3 ID : 7155053660

Option 4 ID : 7155053658

Status : Answered

Chosen Option : 1

Q.44 All structures given below are of vitamin C. Most stable of them is :

Options

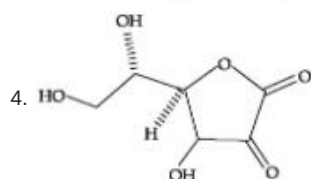
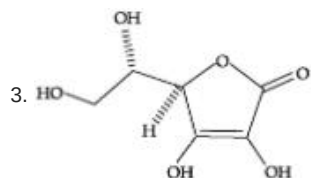
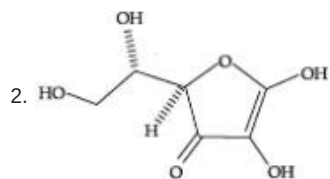
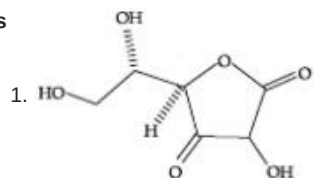

Question Type : MCQ

Question ID : 7155051219

Option 1 ID : 7155053675

Option 2 ID : 7155053676

Option 3 ID : 7155053673

Option 4 ID : 7155053674

Status : Answered

Chosen Option : 2

Q.45

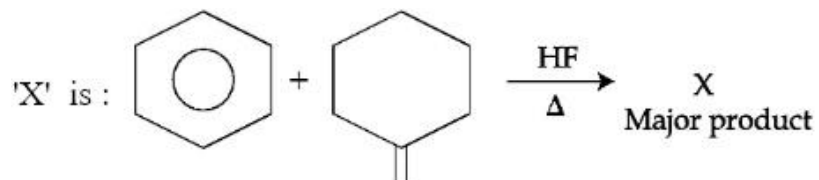

Options

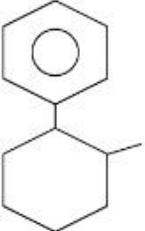
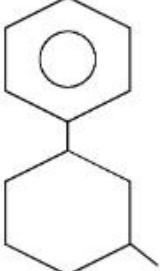
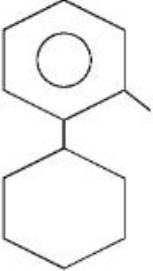
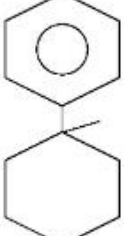
1. 
2. 
3. 
4. 

Question Type : MCQ

Question ID : 7155051213

Option 1 ID : 7155053651

Option 2 ID : 7155053652

Option 3 ID : 7155053650

Option 4 ID : 7155053649

Status : Answered

Chosen Option : 2

Q.46 The industrial activity held least responsible for global warming is :

- Options
1. Electricity generation in thermal power plants
 2. Industrial production of urea
 3. manufacturing of cement
 4. steel manufacturing

Question Type : MCQ
Question ID : 7155051211
Option 1 ID : 7155053642
Option 2 ID : 7155053641
Option 3 ID : 7155053643
Option 4 ID : 7155053644
Status : Answered
Chosen Option : 3

Q.47 For electron gain enthalpies of the elements denoted as $\Delta_{eg}H$, the incorrect option is :

- Options
1. $\Delta_{eg}H(I) < \Delta_{eg}H(At)$
 2. $\Delta_{eg}H(Cl) < \Delta_{eg}H(F)$
 3. $\Delta_{eg}H(Te) < \Delta_{eg}H(Po)$
 4. $\Delta_{eg}H(Se) < \Delta_{eg}H(S)$

Question Type : MCQ
Question ID : 7155051205
Option 1 ID : 7155053620
Option 2 ID : 7155053618
Option 3 ID : 7155053619
Option 4 ID : 7155053617
Status : Answered
Chosen Option : 3

Q.48 The correct order of bond enthalpy (kJ mol^{-1}) is :

- Options
1. $C - C > Si - Si > Ge - Ge > Sn - Sn$
 2. $C - C > Si - Si > Sn - Sn > Ge - Ge$
 3. $Si - Si > C - C > Ge - Ge > Sn - Sn$
 4. $Si - Si > C - C > Sn - Sn > Ge - Ge$

Question Type : MCQ
Question ID : 7155051208
Option 1 ID : 7155053632
Option 2 ID : 7155053629
Option 3 ID : 7155053630
Option 4 ID : 7155053631
Status : Answered
Chosen Option : 1

Q.49 Given below are two statements : one is labelled as **Assertion (A)** and the other is labelled as **Reason (R)**.

Assertion (A) : α -halocarboxylic acid on reaction with dil NH_3 gives good yield of α -amino carboxylic acid whereas the yield of amines is very low when prepared from alkyl halides.

Reason (R) : Amino acids exist in zwitter ion form in aqueous medium.

In the light of the above statements, choose the **correct** answer from the options given below :

Options 1.

Both (A) and (R) are correct but (R) is **not** the correct explanation of (A)

2. (A) is not correct but (R) is correct

3. (A) is correct but (R) is not correct

4.

Both (A) and (R) are correct and (R) is the correct explanation of (A)

Question Type : MCQ

Question ID : 7155051217

Option 1 ID : 7155053666

Option 2 ID : 7155053668

Option 3 ID : 7155053667

Option 4 ID : 7155053665

Status : Answered

Chosen Option : 1

Q.50 The complex cation which has two isomers is :

Options 1. $[\text{Co}(\text{NH}_3)_5\text{Cl}]^{2+}$

2. $[\text{Co}(\text{NH}_3)_5\text{NO}_2]^{2+}$

3. $[\text{Co}(\text{NH}_3)_5\text{Cl}]^+$

4. $[\text{Co}(\text{H}_2\text{O})_6]^{3+}$

Question Type : MCQ

Question ID : 7155051210

Option 1 ID : 7155053640

Option 2 ID : 7155053639

Option 3 ID : 7155053637

Option 4 ID : 7155053638

Status : Answered

Chosen Option : 2

Section : Chemistry Section B

Q.51 The molality of a 10% (v/v) solution of di-bromine solution in CCl_4 (carbon tetrachloride) is 'x'.

$x = \text{_____} \times 10^{-2}$ M. (Nearest integer)

[Given : molar mass of $\text{Br}_2 = 160 \text{ g mol}^{-1}$

atomic mass of C = 12 g mol^{-1}

atomic mass of Cl = 35.5 g mol^{-1}

density of dibromine = 3.2 g cm^{-3}

density of $\text{CCl}_4 = 1.6 \text{ g cm}^{-3}$]

Given 1583

Answer :

Question Type : SA

Question ID : 7155051221

Status : Answered

Q.52 $A \rightarrow B$
The above reaction is of zero order. Half life of this reaction is 50 min. The time taken for the concentration of A to reduce to one-fourth of its initial value is _____ min.
(Nearest integer)

Given 0.7
Answer :

Question Type : SA
Question ID : 7155051226
Status : Answered

Q.53 0.3 g of ethane undergoes combustion at 27°C in a bomb calorimeter. The temperature of calorimeter system (including the water) is found to rise by 0.5°C . The heat evolved during combustion of ethane at constant pressure is _____ kJ mol^{-1} .
(Nearest integer)

[Given : The heat capacity of the calorimeter system is 20 kJ K^{-1} , $R = 8.3 \text{ JK}^{-1} \text{ mol}^{-1}$.
Assume ideal gas behaviour.
Atomic mass of C and H are 12 and 1 g mol^{-1} respectively]

Given --
Answer :

Question Type : SA
Question ID : 7155051224
Status : Not Answered

Q.54 The spin only magnetic moment of $[\text{Mn}(\text{H}_2\text{O})_6]^{2+}$ complexes is _____ B.M. (Nearest integer)

(Given: Atomic no. of Mn is 25)

Given --
Answer :

Question Type : SA
Question ID : 7155051227
Status : Not Answered

Q.55 20% of acetic acid is dissociated when its 5 g is added to 500 mL of water. The depression in freezing point of such water is _____ $\times 10^{-3}^\circ\text{C}$.
Atomic mass of C, H and O are 12, 1 and 16 a.m.u. respectively.
[Given : Molal depression constant and density of water are $1.86 \text{ K kg mol}^{-1}$ and 1 g cm^{-3} respectively.]

Given --
Answer :

Question Type : SA
Question ID : 7155051223
Status : Not Answered

Q.56 A metal M crystallizes into two lattices :- face centred cubic (fcc) and body centred cubic (bcc) with unit cell edge length of 2.0 and 2.5 Å respectively. The ratio of densities of lattices fcc to bcc for the metal M is _____.
(Nearest integer)

Given --
Answer :

Question Type : SA
Question ID : 7155051222
Status : Not Answered

Q.57 Among the following, the number of tranquilizer/s is/are _____.

- A. Chloroliazepoxide
- B. Veronal
- C. Valium
- D. Salvarsan

Given 2
Answer :

Question Type : SA
Question ID : 7155051229
Status : Answered

Q.58 Among following compounds, the number of those present in copper matte is _____.

- A. CuCO_3
- B. Cu_2S
- C. Cu_2O
- D. FeO

Given 3
Answer :

Question Type : SA
Question ID : 7155051228
Status : Answered

Q.59 $1 \times 10^{-5} \text{ M AgNO}_3$ is added to 1 L of saturated solution of AgBr . The conductivity of this solution at 298 K is _____ $\times 10^{-8} \text{ S m}^{-1}$.

[Given : $K_{\text{sp}}(\text{AgBr}) = 4.9 \times 10^{-13}$ at 298 K

$$\lambda_{\text{Ag}^+}^0 = 6 \times 10^{-3} \text{ S m}^2 \text{ mol}^{-1}$$

$$\lambda_{\text{Br}^-}^0 = 8 \times 10^{-3} \text{ S m}^2 \text{ mol}^{-1}$$

$$\lambda_{\text{NO}_3^-}^0 = 7 \times 10^{-3} \text{ S m}^2 \text{ mol}^{-1}]$$

Given --
Answer :

Question Type : SA
Question ID : 7155051225
Status : Not Answered

Q.60 Testosterone, which is a steroidal hormone, has the following structure.

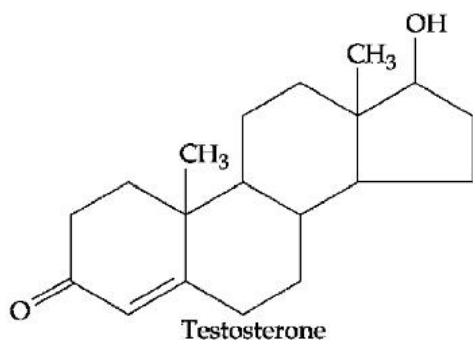

The total number of asymmetric carbon atom/s in testosterone is _____.

Given 13
Answer :

Question Type : SA
Question ID : 7155051230
Status : Answered

Section : Mathematics Section A

Q.61 The number of integral values of k , for which one root of the equation $2x^2 - 8x + k = 0$ lies in the interval $(1, 2)$ and its other root lies in the interval $(2, 3)$, is :

- Options 1. 0
2. 1
3. 2
4. 3

Question Type : MCQ

Question ID : 7155051233

Option 1 ID : 7155053699

Option 2 ID : 7155053700

Option 3 ID : 7155053701

Option 4 ID : 7155053702

Status : Answered

Chosen Option : 3

Q.62 Let $\alpha x = \exp(x^\beta y^\gamma)$ be the solution of the differential equation $2x^2y \, dy - (1 - xy^2) \, dx = 0$, $x > 0$, $y(2) = \sqrt{\log_e 2}$. Then $\alpha + \beta - \gamma$ equals :

- Options 1. 3
2. 1
3. 0
4. -1

Question Type : MCQ

Question ID : 7155051242

Option 1 ID : 7155053736

Option 2 ID : 7155053735

Option 3 ID : 7155053738

Option 4 ID : 7155053737

Status : Answered

Chosen Option : 3

Q.63 The area of the region given by $\{(x,y) : xy \leq 8, 1 \leq y \leq x^2\}$ is :

- Options 1. $16 \log_e 2 - \frac{14}{3}$
2. $16 \log_e 2 + \frac{7}{3}$
3. $8 \log_e 2 - \frac{13}{3}$
4. $8 \log_e 2 + \frac{7}{6}$

Question Type : MCQ

Question ID : 7155051241

Option 1 ID : 7155053732

Option 2 ID : 7155053734

Option 3 ID : 7155053733

Option 4 ID : 7155053731

Status : Answered

Chosen Option : 2

Q.64 Let $9 = x_1 < x_2 < \dots < x_7$ be in an A.P. with common difference d . If the standard deviation of x_1, x_2, \dots, x_7 is 4 and the mean is \bar{x} , then $\bar{x} + x_6$ is equal to :

Options

1. $2\left(9 + \frac{8}{\sqrt{7}}\right)$
2. 25
3. $18\left(1 + \frac{1}{\sqrt{3}}\right)$
4. 34

Question Type : MCQ

Question ID : 7155051247

Option 1 ID : 7155053757

Option 2 ID : 7155053755

Option 3 ID : 7155053758

Option 4 ID : 7155053756

Status : Answered

Chosen Option : 4

Q.65 For the system of linear equations $\alpha x + y + z = 1, x + \alpha y + z = 1, x + y + \alpha z = \beta$, which one of the following statements is NOT correct ?

Options

1. It has no solution if $\alpha = -2$ and $\beta = 1$
2. It has infinitely many solutions if $\alpha = 1$ and $\beta = 1$
3. $x + y + z = \frac{3}{4}$ if $\alpha = 2$ and $\beta = 1$
4. It has infinitely many solutions if $\alpha = 2$ and $\beta = -1$

Question Type : MCQ

Question ID : 7155051235

Option 1 ID : 7155053708

Option 2 ID : 7155053707

Option 3 ID : 7155053710

Option 4 ID : 7155053709

Status : Answered

Chosen Option : 1

Q.66 Let $P(S)$ denote the power set of $S = \{1, 2, 3, \dots, 10\}$. Define the relations R_1 and R_2 on $P(S)$ as $A R_1 B$ if $(A \cap B^c) \cup (B \cap A^c) = \emptyset$ and $A R_2 B$ if $A \cup B^c = B \cup A^c, \forall A, B \in P(S)$. Then :

Options

1. only R_1 is an equivalence relation
2. both R_1 and R_2 are not equivalence relations
3. both R_1 and R_2 are equivalence relations
4. only R_2 is an equivalence relation

Question Type : MCQ

Question ID : 7155051231

Option 1 ID : 7155053692

Option 2 ID : 7155053694

Option 3 ID : 7155053691

Option 4 ID : 7155053693

Status : Answered

Chosen Option : 1

Q.67 Let $P(x_0, y_0)$ be the point on the hyperbola $3x^2 - 4y^2 = 36$, which is nearest to the line $3x + 2y = 1$.
Then $\sqrt{2} (y_0 - x_0)$ is equal to :

- Options**
1. **-9**
 2. -3
 3. 3
 4. 9

Question Type : **MCQ**
 Question ID : **7155051243**
 Option 1 ID : **7155053739**
 Option 2 ID : **7155053742**
 Option 3 ID : **7155053741**
 Option 4 ID : **7155053740**
 Status : **Not Answered**
 Chosen Option : --

Q.68 Let $S = \left\{ x \in \mathbf{R} : 0 < x < 1 \text{ and } 2 \tan^{-1} \left(\frac{1-x}{1+x} \right) = \cos^{-1} \left(\frac{1-x^2}{1+x^2} \right) \right\}$.

If $n(S)$ denotes the number of elements in S then :

- Options**
1. $n(S) = 1$ and the element in S is less than $\frac{1}{2}$.
 2. $n(S) = 0$
 3. $n(S) = 1$ and the elements in S is more than $\frac{1}{2}$.
 4. $n(S) = 2$ and only one element in S is less than $\frac{1}{2}$.

Question Type : **MCQ**
 Question ID : **7155051249**
 Option 1 ID : **7155053763**
 Option 2 ID : **7155053764**
 Option 3 ID : **7155053766**
 Option 4 ID : **7155053765**
 Status : **Answered**
 Chosen Option : **1**

Q.69 Let $\vec{a} = 2\hat{i} - 7\hat{j} + 5\hat{k}$, $\vec{b} = \hat{i} + \hat{k}$ and $\vec{c} = \hat{i} + 2\hat{j} - 3\hat{k}$ be three given vectors. If \vec{r} is a vector
such that $\vec{r} \times \vec{a} = \vec{c} \times \vec{a}$ and $\vec{r} \cdot \vec{b} = 0$, then $|\vec{r}|$ is equal to :

- Options**
1. $\frac{11}{7}$
 2. $\frac{11}{7}\sqrt{2}$
 3. $\frac{11}{5}\sqrt{2}$
 4. $\frac{\sqrt{914}}{7}$

Question Type : **MCQ**
 Question ID : **7155051245**
 Option 1 ID : **7155053747**
 Option 2 ID : **7155053748**
 Option 3 ID : **7155053749**
 Option 4 ID : **7155053750**
 Status : **Answered**
 Chosen Option : **2**

Q.70 Two dice are thrown independently. Let A be the event that the number appeared on the 1st die is less than the number appeared on the 2nd die, B be the event that the number appeared on the 1st die is even and that on the second die is odd, and C be the event that the number appeared on the 1st die is odd and that on the 2nd is even. Then :

Options 1. B and C are independent

2.

the number of favourable cases of the events A, B and C are 15, 6 and 6 respectively

3. A and B are mutually exclusive

4.

the number of favourable cases of the event $(A \cup B) \cap C$ is 6

Question Type : MCQ

Question ID : 7155051246

Option 1 ID : 7155053752

Option 2 ID : 7155053751

Option 3 ID : 7155053753

Option 4 ID : 7155053754

Status : Answered

Chosen Option : 4

Q.71 Let a, b be two real numbers such that $ab < 0$. If the complex number $\frac{1+ai}{b+i}$ is of unit modulus and $a + ib$ lies on the circle $|z - I| = |2z|$, then a possible value of $\frac{1+[a]}{4b}$, where $[t]$ is greatest integer function, is :

Options 1. $-\frac{1}{2}$

2. 1

3. -1

4. $\frac{1}{2}$

Question Type : MCQ

Question ID : 7155051232

Option 1 ID : 7155053695

Option 2 ID : 7155053698

Option 3 ID : 7155053697

Option 4 ID : 7155053696

Status : Answered

Chosen Option : 4

Q.72 If $A = \frac{1}{2} \begin{bmatrix} 1 & \sqrt{3} \\ -\sqrt{3} & 1 \end{bmatrix}$, then :

Options 1. $A^{30} + A^{25} - A = I$

2. $A^{30} = A^{25}$

3. $A^{30} + A^{25} + A = I$

4. $A^{30} - A^{25} = 2I$

Question Type : MCQ

Question ID : 7155051234

Option 1 ID : 7155053706

Option 2 ID : 7155053703

Option 3 ID : 7155053705

Option 4 ID : 7155053704

Status : Answered

Chosen Option : 2

Q.73 Let the plane P pass through the intersection of the planes $2x + 3y - z = 2$ and $x + 2y + 3z = 6$, and be perpendicular to the plane $2x + y - z + 1 = 0$. If d is the distance of P from the point $(-7, 1, 1)$, then d^2 is equal to :

- Options
1. $\frac{25}{83}$
 2. $\frac{250}{83}$
 3. $\frac{250}{82}$
 4. $\frac{15}{53}$

Question Type : MCQ

Question ID : 7155051244

Option 1 ID : 7155053746

Option 2 ID : 7155053743

Option 3 ID : 7155053744

Option 4 ID : 7155053745

Status : Answered

Chosen Option : 1

Q.74

The value of the integral $\int_{-\frac{\pi}{4}}^{\frac{\pi}{4}} \frac{x + \frac{\pi}{4}}{2 - \cos 2x} dx$ is :

- Options
1. $\frac{\pi^2}{6\sqrt{3}}$
 2. $\frac{\pi^2}{3\sqrt{3}}$
 3. $\frac{\pi^2}{6}$
 4. $\frac{\pi^2}{12\sqrt{3}}$

Question Type : MCQ

Question ID : 7155051240

Option 1 ID : 7155053729

Option 2 ID : 7155053727

Option 3 ID : 7155053728

Option 4 ID : 7155053730

Status : Answered

Chosen Option : 3

Q.75 Let $\vec{a} = 5\hat{i} - \hat{j} - 3\hat{k}$ and $\vec{b} = \hat{i} + 3\hat{j} + 5\hat{k}$ be two vectors. Then which one of the following statements is TRUE ?

Options 1.

Projection of \vec{a} on \vec{b} is $\frac{-17}{\sqrt{35}}$ and the direction of the projection vector is opposite to the direction of \vec{b} .

2.

Projection of \vec{a} on \vec{b} is $\frac{17}{\sqrt{35}}$ and the direction of the projection vector is opposite to the direction of \vec{b} .

3.

Projection of \vec{a} on \vec{b} is $\frac{17}{\sqrt{35}}$ and the direction of the projection vector is same as of \vec{b} .

4.

Projection of \vec{a} on \vec{b} is $\frac{-17}{\sqrt{35}}$ and the direction of the projection vector is same as of \vec{b} .

Question Type : MCQ

Question ID : 7155051248

Option 1 ID : 7155053760

Option 2 ID : 7155053762

Option 3 ID : 7155053761

Option 4 ID : 7155053759

Status : Answered

Chosen Option : 1

Q.76 If $y(x) = x^x$, $x > 0$, then $y''(2) - 2y'(2)$ is equal to :

Options 1. $8 \log_e 2 - 2$

2. $4 \log_e 2 + 2$

3. $4 (\log_e 2)^2 + 2$

4. $4 (\log_e 2)^2 - 2$

Question Type : MCQ

Question ID : 7155051238

Option 1 ID : 7155053719

Option 2 ID : 7155053721

Option 3 ID : 7155053720

Option 4 ID : 7155053722

Status : Answered

Chosen Option : 1

Q.77 Let $f : \mathbb{R} - \{0,1\} \rightarrow \mathbb{R}$ be a function such that $f(x) + f\left(\frac{1}{1-x}\right) = 1+x$. Then $f(2)$ is equal to

- Options
1. $\frac{7}{3}$
 2. $\frac{7}{4}$
 3. $\frac{9}{2}$
 4. $\frac{9}{4}$

Question Type : MCQ

Question ID : 7155051236

Option 1 ID : 7155053713

Option 2 ID : 7155053714

Option 3 ID : 7155053711

Option 4 ID : 7155053712

Status : Answered

Chosen Option : 4

Q.78 The sum $\sum_{n=1}^{\infty} \frac{2n^2 + 3n + 4}{(2n)!}$ is equal to :

- Options
1. $\frac{11e}{2} + \frac{7}{2e} - 4$
 2. $\frac{13e}{4} + \frac{5}{4e} - 4$
 3. $\frac{11e}{2} + \frac{7}{2e}$
 4. $\frac{13e}{4} + \frac{5}{4e}$

Question Type : MCQ

Question ID : 7155051237

Option 1 ID : 7155053718

Option 2 ID : 7155053717

Option 3 ID : 7155053716

Option 4 ID : 7155053715

Status : Answered

Chosen Option : 3

Q.79 Which of the following statements is a tautology ?

- Options
1. $p \vee (p \wedge q)$
 2. $p \rightarrow (p \wedge (p \rightarrow q))$
 3. $(p \wedge (p \rightarrow q)) \rightarrow \sim q$
 4. $(p \wedge q) \rightarrow (\sim(p) \rightarrow q)$

Question Type : MCQ

Question ID : 7155051250

Option 1 ID : 7155053769

Option 2 ID : 7155053767

Option 3 ID : 7155053770

Option 4 ID : 7155053768

Status : Answered

Chosen Option : 4

Q.80 The sum of the absolute maximum and minimum values of the function

$f(x) = |x^2 - 5x + 6| - 3x + 2$ in the interval $[-1, 3]$ is equal to :

- Options 1. 12
2. 24
3. 13
4. 10

Question Type : MCQ

Question ID : 7155051239

Option 1 ID : 7155053724

Option 2 ID : 7155053726

Option 3 ID : 7155053725

Option 4 ID : 7155053723

Status : Answered

Chosen Option : 4

Section : Mathematics Section B

Q.81 The point of intersection C of the plane $8x + y + 2z = 0$ and the line joining the points A(-3, -6, 1) and B(2, 4, -3) divides the line segment AB internally in the ratio $k : 1$. If a, b, c ($|a|, |b|, |c|$ are coprime) are the direction ratios of the perpendicular from the point C on the line

$\frac{1-x}{1} = \frac{y+4}{2} = \frac{z+2}{3}$, then $|a + b + c|$ is equal to _____.

Given --

Answer :

Question Type : SA

Question ID : 7155051260

Status : Not Answered

Q.82 If the x-intercept of a focal chord of the parabola $y^2 = 8x + 4y + 4$ is 3, then the length of this chord is equal to _____.

Given 14

Answer :

Question Type : SA

Question ID : 7155051258

Status : Answered

Q.83 Number of integral solutions to the equation $x + y + z = 21$, where $x \geq 1, y \geq 3, z \geq 4$, is equal to _____.

Given 0

Answer :

Question Type : SA

Question ID : 7155051255

Status : Answered

Q.84 If $\int_0^{\pi} \frac{5^{\cos x} (1 + \cos x \cos 3x + \cos^2 x + \cos^3 x \cos 3x) dx}{1 + 5^{\cos x}} = \frac{k\pi}{16}$, then k is equal to _____.

Given 2

Answer :

Question Type : SA

Question ID : 7155051256

Status : Answered

Q.85 The sum of the common terms of the following three arithmetic progressions.
 3, 7, 11, 15,, 399,
 2, 5, 8, 11,, 359 and
 2, 7, 12, 17,, 197,
 is equal to _____.

Given 0
 Answer :

Question Type : SA
 Question ID : 7155051253
 Status : Answered

Q.86 The line $x = 8$ is the directrix of the ellipse $E: \frac{x^2}{a^2} + \frac{y^2}{b^2} = 1$ with the corresponding focus $(2, 0)$. If the tangent to E at the point P in the first quadrant passes through the point $(0, 4\sqrt{3})$ and intersects the x -axis at Q , then $(3PQ)^2$ is equal to _____.

Given --
 Answer :

Question Type : SA
 Question ID : 7155051259
 Status : Not Answered

Q.87 If the term without x in the expansion of $\left(x^{\frac{2}{3}} + \frac{\alpha}{x^3}\right)^{22}$ is 7315, then $|\alpha|$ is equal to _____.

Given --
 Answer :

Question Type : SA
 Question ID : 7155051254
 Status : Not Answered

Q.88 Let $ax + \beta y + \gamma z = 1$ be the equation of a plane passing through the point $(3, -2, 5)$ and perpendicular to the line joining the points $(1, 2, 3)$ and $(-2, 3, 5)$. Then the value of $\alpha\beta\gamma$ is equal to _____.

Given --
 Answer :

Question Type : SA
 Question ID : 7155051257
 Status : Not Answered

Q.89 Let the sixth term in the binomial expansion of $\left(\sqrt{2^{\log_2(10-3^x)}} + \sqrt[5]{2^{(x-2)\log_2 3}}\right)^m$, in the increasing powers of $2^{(x-2)\log_2 3}$, be 21. If the binomial coefficients of the second, third and fourth terms in the expansion are respectively the first, third and fifth terms of an A.P., then the sum of the squares of all possible values of x is _____.

Given --
 Answer :

Question Type : SA
 Question ID : 7155051252
 Status : Not Answered

Q.90 The total number of six digit numbers, formed using the digits 4, 5, 9 only and divisible by 6, is _____.

Given 2

Answer :

Question Type : SA

Question ID : 7155051251

Status : Answered