

JEE 2023 Session-1 24th Jan to 1st Feb 2023

Application No	230310133390
Candidate Name	YASH GANESH JADHAV
Roll No	MR16001433
Test Date	24/01/2023
Test Time	3:00 PM - 6:00 PM
Subject	B TECH

Section : Physics Section A

Q.1 A body of mass 200g is tied to a spring of spring constant 12.5 N/m, while the other end of spring is fixed at point O. If the body moves about O in a circular path on a smooth horizontal surface with constant angular speed 5 rad/s. Then the ratio of extension in the spring to its natural length will be :

- Options**
1. 2:3
 2. 1:2
 3. 1:1
 4. 2:5

Question Type : **MCQ**

Question ID : **7155051535**

Option 1 ID : **7155054609**

Option 2 ID : **7155054608**

Option 3 ID : **7155054607**

Option 4 ID : **7155054610**

Status : **Answered**

Chosen Option : **1**

Q.2 Match List I with List II

LIST I		LIST II	
A.	AM Broadcast	I.	88–108 MHz
B.	FM Broadcast	II.	540–1600 kHz
C.	Television	III.	3.7–4.2 GHz
D.	Satellite Communication	IV.	54MHz _z – 890MHz

Choose the correct answer from the options given below:

- Options**
1. A-II, B-I, C-IV, D-III
 2. A-IV, B-III, C-I, D-II
 3. A-I, B-III, C-II, D-IV
 4. A-II, B-III, C-I, D-IV

Question Type : **MCQ**

Question ID : **7155051540**

Option 1 ID : **7155054628**

Option 2 ID : **7155054630**

Option 3 ID : **7155054627**

Option 4 ID : **7155054629**

Status : **Not Answered**

Chosen Option : **--**

Q.3 The frequency (ν) of an oscillating liquid drop may depend upon radius (r) of the drop, density (ρ) of liquid and the surface tension (s) of the liquid as : $\nu = r^a \rho^b s^c$. The values of a, b and c respectively are

Options

1. $\left(\frac{3}{2}, \frac{1}{2}, -\frac{1}{2}\right)$

2. $\left(-\frac{3}{2}, \frac{1}{2}, \frac{1}{2}\right)$

3. $\left(-\frac{3}{2}, -\frac{1}{2}, \frac{1}{2}\right)$

4. $\left(\frac{3}{2}, -\frac{1}{2}, \frac{1}{2}\right)$

Question Type : **MCQ**

Question ID : **7155051531**

Option 1 ID : **7155054594**

Option 2 ID : **7155054593**

Option 3 ID : **7155054591**

Option 4 ID : **7155054592**

Status : **Not Answered**

Chosen Option : --

Q.4 The electric potential at the centre of two concentric half rings of radii R_1 and R_2 , having same linear charge density λ is :

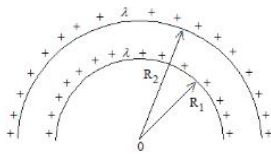

Options

1. $\frac{\lambda}{4\epsilon_0}$

2. $\frac{2\lambda}{\epsilon_0}$

3. $\frac{\lambda}{2\epsilon_0}$

4. $\frac{\lambda}{\epsilon_0}$

Question Type : **MCQ**

Question ID : **7155051541**

Option 1 ID : **7155054633**

Option 2 ID : **7155054634**

Option 3 ID : **7155054632**

Option 4 ID : **7155054631**

Status : **Not Answered**

Chosen Option : --

Q.5 If the distance of the earth from Sun is 1.5×10^6 km. Then the distance of an imaginary planet from Sun, if its period of revolution is 2.83 years is :

- Options**
1. 3×10^6 km
 2. 3×10^7 km
 3. 6×10^7 km
 4. 6×10^6 km

Question Type : **MCQ**

Question ID : **7155051537**

Option 1 ID : **7155054615**

Option 2 ID : **7155054617**

Option 3 ID : **7155054618**

Option 4 ID : **7155054616**

Status : **Not Answered**

Chosen Option : --

Q.6 Let γ_1 be the ratio of molar specific heat at constant pressure and molar specific heat at constant volume of a monoatomic gas and γ_2 be the similar ratio of diatomic gas. Considering the diatomic gas molecule as a rigid rotator, the ratio, $\frac{\gamma_1}{\gamma_2}$ is :

- Options**
1. $\frac{21}{25}$
 2. $\frac{35}{27}$
 3. $\frac{27}{35}$
 4. $\frac{25}{21}$

Question Type : **MCQ**

Question ID : **7155051550**

Option 1 ID : **7155054668**

Option 2 ID : **7155054669**

Option 3 ID : **7155054670**

Option 4 ID : **7155054667**

Status : **Not Answered**

Chosen Option : --

Q.7 Given below are two statements: one is labelled as **Assertion A** and the other is labelled as **Reason R**.

Assertion A : A pendulum clock when taken to Mount Everest becomes fast.

Reason R : The value of g (acceleration due to gravity) is less at Mount Everest than its value on the surface of earth.

In the light of the above statements, choose the *most appropriate* answer from the options given below

- Options**
1. **A** is correct but **R** is not correct
 2. Both **A** and **R** are correct but **R** is **NOT** the correct explanation of **A**
 3. **A** is not correct but **R** is correct
 4. Both **A** and **R** are correct and **R** is the correct explanation of **A**

Question Type : MCQ

Question ID : 7155051539

Option 1 ID : 7155054625

Option 2 ID : 7155054624

Option 3 ID : 7155054626

Option 4 ID : 7155054623

Status : Not Answered

Chosen Option : --

Q.8 Given below are two statements:

Statement I : Acceleration due to earth's gravity decreases as you go 'up' or 'down' from earth's surface.

Statement II : Acceleration due to earth's gravity is same at a height 'h' and depth 'd' from earth's surface, if $h = d$.

In the light of above statements, choose the *most appropriate* answer form the options given below

- Options**
1. **Statement I** is incorrect but **statement II** is correct
 2. Both **Statement I** and **Statement II** are incorrect
 3. Both **Statement I** and **II** are correct
 4. **Statement I** is correct but **statement II** is incorrect

Question Type : MCQ

Question ID : 7155051536

Option 1 ID : 7155054614

Option 2 ID : 7155054612

Option 3 ID : 7155054611

Option 4 ID : 7155054613

Status : Answered

Chosen Option : 4

Q.9 A metallic rod of length 'L' is rotated with an angular speed of ' ω ' normal to a uniform magnetic field 'B' about an axis passing through one end of rod as shown in figure. The induced emf will be :

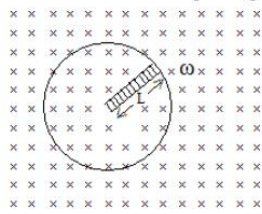

Options

1. $\frac{1}{2} B^2 L^2 \omega$
2. $\frac{1}{4} BL^2 \omega$
3. $\frac{1}{4} B^2 L \omega$
4. $\frac{1}{2} BL^2 \omega$

Question Type : MCQ

Question ID : 7155051538

Option 1 ID : 7155054620

Option 2 ID : 7155054619

Option 3 ID : 7155054621

Option 4 ID : 7155054622

Status : Not Answered

Chosen Option : --

Q.10 If two vectors $\vec{p} = \hat{i} + 2m\hat{j} + m\hat{k}$ and $\vec{Q} = 4\hat{i} - 2\hat{j} + m\hat{k}$ are perpendicular to each other. Then, the value of m will be :

- Options
1. 1
 2. 2
 3. 3
 4. -1

Question Type : MCQ

Question ID : 7155051532

Option 1 ID : 7155054597

Option 2 ID : 7155054596

Option 3 ID : 7155054595

Option 4 ID : 7155054598

Status : Answered

Chosen Option : 2

Q.11 The electric field and magnetic field components of an electromagnetic wave going through vacuum is described by

$$E_x = E_0 \sin(kz - \omega t)$$

$$B_y = B_0 \sin(kz - \omega t)$$

Then the correct relation between E_0 and B_0 is given by

- Options**
1. $E_0 = kB_0$
 2. $E_0 B_0 = \omega k$
 3. $\omega E_0 = kB_0$
 4. $kE_0 = \omega B_0$

Question Type : **MCQ**

Question ID : **7155051545**

Option 1 ID : **7155054647**

Option 2 ID : **7155054650**

Option 3 ID : **7155054649**

Option 4 ID : **7155054648**

Status : **Not Answered**

Chosen Option : --

Q.12

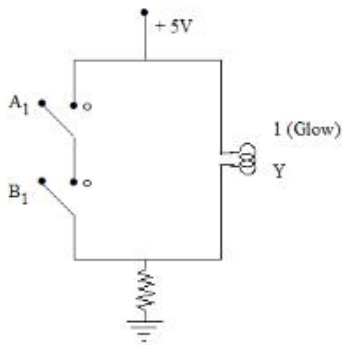

The logic gate equivalent to the given circuit diagram is :

- Options**
1. **OR**
 2. **NAND**
 3. **NOR**
 4. **AND**

Question Type : **MCQ**

Question ID : **7155051549**

Option 1 ID : **7155054665**

Option 2 ID : **7155054664**

Option 3 ID : **7155054666**

Option 4 ID : **7155054663**

Status : **Answered**

Chosen Option : **4**

Q.13 An α -particle, a proton and an electron have the same kinetic energy. Which one of the following is correct in case of their de-Broglie wavelength:

- Options**
1. $\lambda_\alpha > \lambda_p > \lambda_e$
 2. $\lambda_\alpha = \lambda_p = \lambda_e$
 3. $\lambda_\alpha < \lambda_p < \lambda_e$
 4. $\lambda_\alpha > \lambda_p < \lambda_e$

Question Type : **MCQ**

Question ID : **7155051543**

Option 1 ID : **7155054640**

Option 2 ID : **7155054639**

Option 3 ID : **7155054641**

Option 4 ID : **7155054642**

Status : **Answered**

Chosen Option : **3**

Q.14 When a beam of white light is allowed to pass through convex lens parallel to principal axis, the different colours of light converge at different point on the principle axis after refraction. This is called :

- Options**
1. **Chromatic aberration**
 2. **Polarisation**
 3. **Spherical aberration**
 4. **Scattering**

Question Type : **MCQ**

Question ID : **7155051544**

Option 1 ID : **7155054646**

Option 2 ID : **7155054644**

Option 3 ID : **7155054643**

Option 4 ID : **7155054645**

Status : **Answered**

Chosen Option : **4**

Q.15 A long solenoid is formed by winding 70 turns cm^{-1} . If 2.0 A current flows, then the magnetic field produced inside the solenoid is _____ ($\mu_0 = 4\pi \times 10^{-7} \text{ TmA}^{-1}$)

- Options**
1. $88 \times 10^{-4} \text{ T}$
 2. $176 \times 10^{-4} \text{ T}$
 3. $352 \times 10^{-4} \text{ T}$
 4. $1232 \times 10^{-4} \text{ T}$

Question Type : **MCQ**

Question ID : **7155051546**

Option 1 ID : **7155054651**

Option 2 ID : **7155054652**

Option 3 ID : **7155054653**

Option 4 ID : **7155054654**

Status : **Not Answered**

Chosen Option : **--**

Q.16 The velocity time graph of a body moving in a straight line is shown in figure.

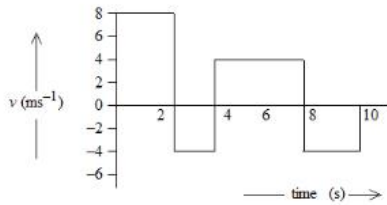

The ratio of displacement to distance travelled by the body in time 0 to 10s is :

- Options
1. 1:4
 2. 1:3
 3. 1:2
 4. 1:1

Question Type : MCQ

Question ID : 7155051534

Option 1 ID : 7155054605

Option 2 ID : 7155054606

Option 3 ID : 7155054604

Option 4 ID : 7155054603

Status : Answered

Chosen Option : 2

Q.17 A photon is emitted in transition from $n = 4$ to $n = 1$ level in hydrogen atom. The corresponding wavelength for this transition is (given, $h = 4 \times 10^{-15}$ eVs) :

- Options
1. 94.1 nm
 2. 99.3 nm
 3. 974 nm
 4. 941 nm

Question Type : MCQ

Question ID : 7155051542

Option 1 ID : 7155054637

Option 2 ID : 7155054635

Option 3 ID : 7155054636

Option 4 ID : 7155054638

Status : Not Answered

Chosen Option : --

Q.18 Given below are two statements: one is labelled as **Assertion A** and the other is labelled as **Reason R**

Assertion A : Steel is used in the construction of buildings and bridges.

Reason R : Steel is more elastic and its elastic limit is high.

In the light of above statements, choose the most appropriate answer from the options given below

- Options
1. **A** is correct but **R** is not correct
 2. **A** is not correct but **R** is correct
 3. Both **A** and **R** are correct but **R** is **NOT** the correct explanation of **A**
 4. Both **A** and **R** are correct and **R** is the correct explanation of **A**

Question Type : MCQ

Question ID : 7155051548

Option 1 ID : 7155054661

Option 2 ID : 7155054662

Option 3 ID : 7155054660

Option 4 ID : 7155054659

Status : Answered

Chosen Option : 4

Q.19 In an Isothermal change, the change in pressure and volume of a gas can be represented for three different temperature; $T_3 > T_2 > T_1$ as :

Options

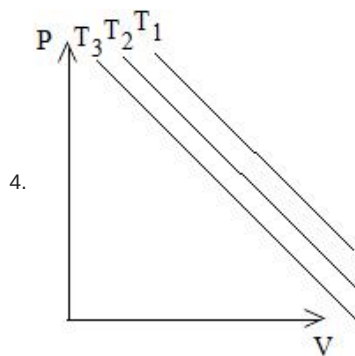
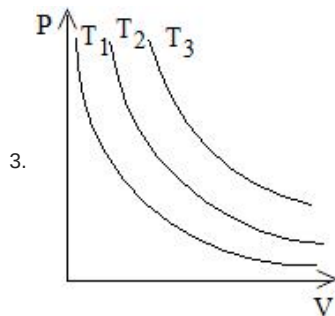
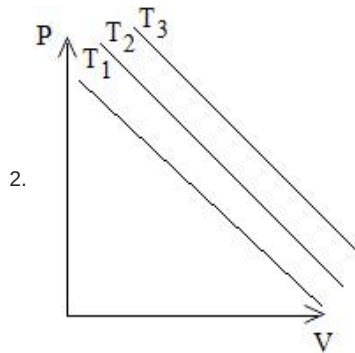
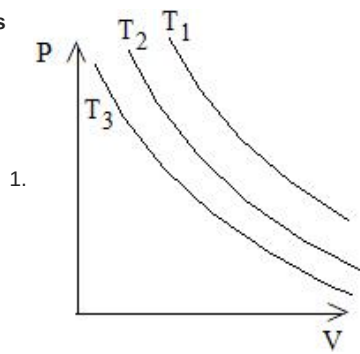

Question Type : **MCQ**

Question ID : **7155051533**

Option 1 ID : **7155054600**

Option 2 ID : **7155054601**

Option 3 ID : **7155054599**

Option 4 ID : **7155054602**

Status : **Answered**

Chosen Option : **3**

Q.20 A cell of emf 90 V is connected across series combination of two resistors each of 100Ω resistance. A voltmeter of resistance 400Ω is used to measure the potential difference across each resistor. The reading of the voltmeter will be :

- Options
1. 45 V
 2. 80 V
 3. 90 V
 4. 40 V

Question Type : MCQ

Question ID : 7155051547

Option 1 ID : 7155054656

Option 2 ID : 7155054657

Option 3 ID : 7155054658

Option 4 ID : 7155054655

Status : Not Answered

Chosen Option : --

Section : Physics Section B

Q.21 A single turn current loop in the shape of a right angle triangle with sides 5 cm, 12 cm, 13 cm is carrying a current of 2 A. The loop is in a uniform magnetic field of magnitude 0.75 T whose direction is parallel to the current in the 13 cm side of the loop. The magnitude of the magnetic force on the 5 cm side will be $\frac{x}{130}$ N. The value of x is _____.

Given --
Answer :

Question Type : SA

Question ID : 7155051557

Status : Not Answered

Q.22 A Spherical ball of radius 1mm and density 10.5 g/cc is dropped in glycerine of coefficient of viscosity 9.8 poise and density 1.5 g/cc. Viscous force on the ball when it attains constant velocity is 3696×10^{-x} N. The value of x is (Given, $g = 9.8 \text{ m/s}^2$ and $\pi = \frac{22}{7}$)

Given --
Answer :

Question Type : SA

Question ID : 7155051552

Status : Not Answered

Q.23 A convex lens of refractive index 1.5 and focal length 18cm in air is immersed in water. The change in focal length of the lens will be _____ cm.

(Given refractive index of water = $\frac{4}{3}$)

Given --
Answer :

Question Type : SA

Question ID : 7155051558

Status : Not Answered

Q.24 A body of mass 1kg begins to move under the action of a time dependent force $\vec{F} = (\hat{i} + 3t^2\hat{j})$ N, where \hat{i} and \hat{j} are the unit vectors along x and y axis. The power developed by above force, at the time $t = 2$ s, will be _____ W.

Given --
Answer :

Question Type : SA

Question ID : 7155051554

Status : Not Answered

Q.25 The energy released per fission of nucleus of ^{240}X is 200 MeV. The energy released if all the atoms in 120g of pure ^{240}X undergo fission is $\text{_____} \times 10^{25}$ MeV.
(Given $N_A = 6 \times 10^{23}$)

Given --
Answer :

Question Type : SA
Question ID : 7155051560
Status : Not Answered

Q.26 A parallel plate capacitor with air between the plate has a capacitance of 15pF. The separation between the plate becomes twice and the space between them is filled with a medium of dielectric constant 3.5. Then the capacitance becomes $\frac{x}{4}$ pF. The value of x is _____.

Given 105
Answer :

Question Type : SA
Question ID : 7155051555
Status : Answered

Q.27 A mass m attached to free end of a spring executes SHM with a period of 1s. If the mass is increased by 3 kg the period of oscillation increases by one second, the value of mass m is _____ kg.

Given 1
Answer :

Question Type : SA
Question ID : 7155051551
Status : Answered

Q.28 A uniform solid cylinder with radius R and length L has moment of inertia I_1 , about the axis of the cylinder. A concentric solid cylinder of radius $R' = \frac{R}{2}$ and length $L' = \frac{L}{2}$ is carved out of the original cylinder. If I_2 is the moment of inertia of the carved out portion of the cylinder then $\frac{I_1}{I_2}$ = _____.

(Both I_1 and I_2 are about the axis of the cylinder)

Given 32
Answer :

Question Type : SA
Question ID : 7155051553
Status : Answered

Q.29 If a copper wire is stretched to increase its length by 20%. The percentage increase in resistance of the wire is _____ %.

Given 24
Answer :

Question Type : SA
Question ID : 7155051556
Status : Answered

- Q.30** Three identical resistors with resistance $R = 12\Omega$ and two identical inductors with self inductance $L = 5\text{ mH}$ are connected to an ideal battery with emf of 12 V as shown in figure. The current through the battery long after the switch has been closed will be _____ A.

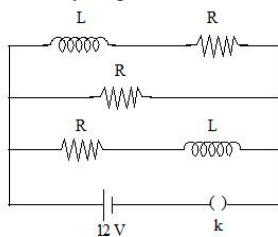

Given --
Answer :

Question Type : SA
Question ID : 7155051559
Status : Not Answered

Section : Chemistry Section A

- Q.31** Which one amongst the following are good oxidizing agents?

- A. Sm^{2+}
- B. Ce^{2+}
- C. Ce^{4+}
- D. Tb^{4+}

Choose the most appropriate answer from the options given below:

- Options
1. C and D only
 2. A and B only
 3. D only
 4. C only

Question Type : MCQ
Question ID : 7155051569
Option 1 ID : 7155054714
Option 2 ID : 7155054713
Option 3 ID : 7155054716
Option 4 ID : 7155054715
Status : Not Answered
Chosen Option : --

- Q.32** Which of the following cannot be explained by crystal field theory?

- Options
1. The order of spectrochemical series
 2. Magnetic properties of transition metal complexes
 3. Colour of metal complexes
 4. Stability of metal complexes

Question Type : MCQ
Question ID : 7155051570
Option 1 ID : 7155054718
Option 2 ID : 7155054717
Option 3 ID : 7155054719
Option 4 ID : 7155054720
Status : Not Answered
Chosen Option : --

Q.33 $K_2Cr_2O_7$ paper acidified with dilute H_2SO_4 turns green when exposed to

- Options
1. Sulphur dioxide
 2. Carbon dioxide
 3. Sulphur trioxide
 4. Hydrogen sulphide

Question Type : MCQ

Question ID : 7155051578

Option 1 ID : 7155054749

Option 2 ID : 7155054752

Option 3 ID : 7155054750

Option 4 ID : 7155054751

Status : Not Answered

Chosen Option : --

Q.34 Find out the major products from the following reactions.



Options

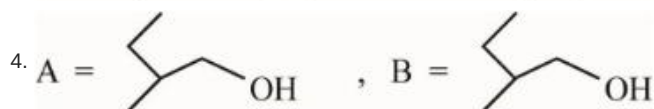

Question Type : MCQ

Question ID : 7155051574

Option 1 ID : 7155054734

Option 2 ID : 7155054736

Option 3 ID : 7155054735

Option 4 ID : 7155054733

Status : Answered

Chosen Option : 1

Q.35 Identify the correct statements about alkali metals.

- A. The order of standard reduction potential ($M^+ | M$) for alkali metal ions is $Na > Rb > Li$.
- B. CsI is highly soluble in water.
- C. Lithium carbonate is highly stable to heat.
- D. Potassium dissolved in concentrated liquid ammonia is blue in colour and paramagnetic.
- E. All the alkali metal hydrides are ionic solids.

Choose the correct answer from the options given below:

Options 1. **C and E only**

2. **A, B, D only**

3. **A, B and E only**

4. **A and E only**

Question Type : **MCQ**

Question ID : **7155051568**

Option 1 ID : **7155054710**

Option 2 ID : **7155054709**

Option 3 ID : **7155054711**

Option 4 ID : **7155054712**

Status : **Answered**

Chosen Option : **1**

Q.36 In which of the following reactions the hydrogen peroxide acts as a reducing agent?

Options 1. $HOCl + H_2O_2 \rightarrow H_3O^+ + Cl^- + O_2$

2. $Mn^{2+} + H_2O_2 \rightarrow Mn^{4+} + 2OH^-$

3. $2Fe^{2+} + H_2O_2 \rightarrow 2Fe^{3+} + 2OH^-$

4. $PbS + 4 H_2O_2 \rightarrow PbSO_4 + 4 H_2O$

Question Type : **MCQ**

Question ID : **7155051566**

Option 1 ID : **7155054702**

Option 2 ID : **7155054703**

Option 3 ID : **7155054704**

Option 4 ID : **7155054701**

Status : **Answered**

Chosen Option : **1**

Q.37 The metal which is extracted by oxidation and subsequent reduction from its ore is:

Options 1. **Al**

2. **Cu**

3. **Ag**

4. **Fe**

Question Type : **MCQ**

Question ID : **7155051565**

Option 1 ID : **7155054698**

Option 2 ID : **7155054699**

Option 3 ID : **7155054700**

Option 4 ID : **7155054697**

Status : **Not Answered**

Chosen Option : **--**

Q.38 Given below are two statements:

Statement I : Pure Aniline and other arylamines are usually colourless.

Statement II : Arylamines get coloured on storage due to atmospheric reduction

In the light of the above statements, choose the most appropriate answer from the options given below:

- Options**
1. Both Statement I and Statement II are incorrect
 2. Statement I is incorrect but Statement II is correct
 3. Statement I is correct but Statement II is incorrect
 4. Both Statement I and Statement II are correct

Question Type : MCQ

Question ID : 7155051579

Option 1 ID : 7155054754

Option 2 ID : 7155054756



Option 3 ID : 7155054755

Option 4 ID : 7155054753

Status : Not Answered

Chosen Option : --

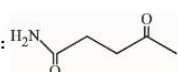
Q.39 Given below are two statements:

Statement I :  under Clemmensen reduction conditions will give  HOOC 

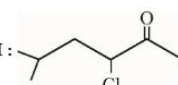
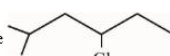
Statement II :  under Wolff-Kishner reduction condition will give 

In the light of the above statements, choose the correct answer from the options given below:

- Options**
1. Statement I is false but Statement II is true
 2. Statement I is true but Statement II is false
 3. Both Statement I and Statement II are false
 4. Both Statement I and Statement II are true

Question Type : MCQ

Question ID : 7155051575

Option 1 ID : 7155054740

Option 2 ID : 7155054739

Option 3 ID : 7155054738

Option 4 ID : 7155054737

Status : Not Answered

Chosen Option : --

Q.40 Given below are two statements, one is labelled as **Assertion A** and the other is labelled as **Reason R**

Assertion A: Beryllium has less negative value of reduction potential compared to the other alkaline earth metals.

Reason R : Beryllium has large hydration energy due to small size of Be^{2+} but relatively large value of atomization enthalpy

In the light of the above statements, choose the most appropriate answer from the options given below

Options 1.

Both A and R are correct and R is the correct explanation of A

2.

Both A and R are correct but R is NOT the correct explanation of A

3. A is correct but R is not correct

4. A is not correct but R is correct

Question Type : MCQ

Question ID : 7155051567

Option 1 ID : 7155054705

Option 2 ID : 7155054706

Option 3 ID : 7155054707

Option 4 ID : 7155054708

Status : Answered

Chosen Option : 4

Q.41 Correct statement is:

Options 1. An average human being consumes more food than air

2.

An average human being consumes equal amount of food and air

3.

An average human being consumes 100 times more air than food

4.

An average human being consumes nearly 15 times more air than food

Question Type : MCQ

Question ID : 7155051571

Option 1 ID : 7155054721

Option 2 ID : 7155054723

Option 3 ID : 7155054722

Option 4 ID : 7155054724

Status : Not Answered

Chosen Option : --

Q.42 Which will undergo deprotonation most readily in basic medium?

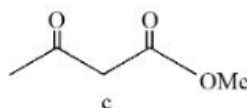
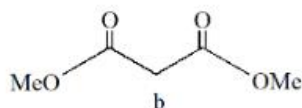
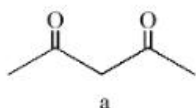

Options 1. a only

2. b only

3. Both a and c

4. c only

Question Type : MCQ

Question ID : 7155051576

Option 1 ID : 7155054741

Option 2 ID : 7155054742

Option 3 ID : 7155054744

Option 4 ID : 7155054743

Status : Answered

Chosen Option : 2

Q.43 Match List I with List II

LIST I		LIST II	
Type		Name	
A.	Antifertility drug	I.	Norethindrone
B.	Tranquilizer	II.	Meprobomate
C.	Antihistamine	III.	Seldane
D.	Antibiotic	IV.	Ampicillin

Choose the correct answer from the options given below:

- Options
1. A-I, B-III, C-II, D-IV
 2. A-I, B-II, C-III, D-IV
 3. A-II, B-I, C-III, D-IV
 4. A-IV, B-III, C-II, D-I

Question Type : MCQ

Question ID : 7155051573

Option 1 ID : 7155054732

Option 2 ID : 7155054730

Option 3 ID : 7155054731

Option 4 ID : 7155054729

Status : Answered

Chosen Option : 1

Q.44 Choose the correct representation of conductometric titration of benzoic acid vs sodium hydroxide.

Options

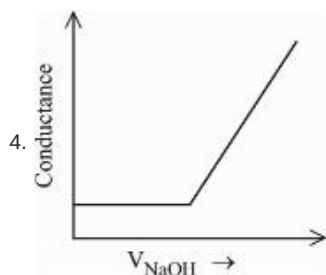
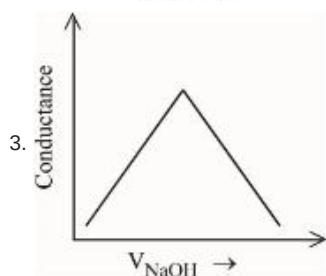
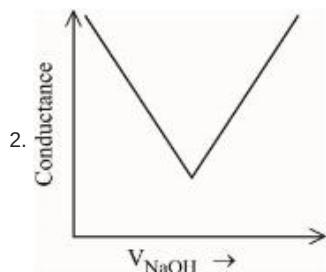
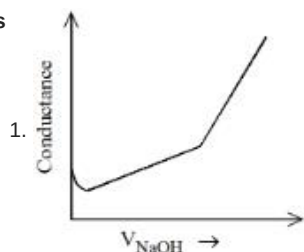

Question Type : MCQ

Question ID : 7155051562

Option 1 ID : 7155054688

Option 2 ID : 7155054685

Option 3 ID : 7155054686

Option 4 ID : 7155054687

Status : Not Answered

Chosen Option : --

Q.45 Given below are two statements, one is labelled as **Assertion A** and the other is labelled as **Reason R**

Assertion A : Benzene is more stable than hypothetical cyclohexatriene

Reason R : The delocalized π electron cloud is attracted more strongly by nuclei of carbon atoms.

In the light of the above statements, choose the correct answer from the options given below:

- Options
1. A is false but R is true
 2. Both A and R are correct but R is NOT the correct explanation of A
 3. A is true but R is false
 4. Both A and R are correct and R is the correct explanation of A

Question Type : MCQ

Question ID : 7155051577

Option 1 ID : 7155054748

Option 2 ID : 7155054746

Option 3 ID : 7155054747

Option 4 ID : 7155054745

Status : Answered

Chosen Option : 2

Q.46 The number of s-electrons present in an ion with 55 protons in its unipositive state is

- Options
1. 10
 2. 9
 3. 12
 4. 8

Question Type : MCQ

Question ID : 7155051564

Option 1 ID : 7155054695

Option 2 ID : 7155054694

Option 3 ID : 7155054696

Option 4 ID : 7155054693

Status : Not Answered

Chosen Option : --

Q.47 The hybridization and magnetic behaviour of cobalt ion in $[\text{Co}(\text{NH}_3)_6]^{3+}$ complex, respectively is

- Options
1. sp^3d^2 and paramagnetic
 2. d^2sp^3 and paramagnetic
 3. d^2sp^3 and diamagnetic
 4. sp^3d^2 and diamagnetic

Question Type : MCQ

Question ID : 7155051572

Option 1 ID : 7155054725

Option 2 ID : 7155054728

Option 3 ID : 7155054727

Option 4 ID : 7155054726

Status : Answered

Chosen Option : 1

Q.48 A student has studied the decomposition of a gas AB_3 at 25°C . He obtained the following data.

p (mm Hg)	50	100	200	400
relative $t_{1/2}$ (s)	4	2	1	0.5

The order of the reaction is

- Options**
- 2
 - 0.5
 - 0 (zero)
 - 1

Question Type : MCQ

Question ID : 7155051563

Option 1 ID : 7155054692

Option 2 ID : 7155054690

Option 3 ID : 7155054689

Option 4 ID : 7155054691

Status : Not Answered

Chosen Option : --

Q.49 What is the number of unpaired electron(s) in the highest occupied molecular orbital of the following species : N_2 ; N_2^+ ; O_2 ; O_2^+ ?

- Options**
- 2, 1, 0, 1
 - 0, 1, 0, 1
 - 0, 1, 2, 1
 - 2, 1, 2, 1

Question Type : MCQ

Question ID : 7155051561

Option 1 ID : 7155054684

Option 2 ID : 7155054682

Option 3 ID : 7155054683

Option 4 ID : 7155054681

Status : Answered

Chosen Option : 3

Q.50 Choose the correct colour of the product for the following reaction.

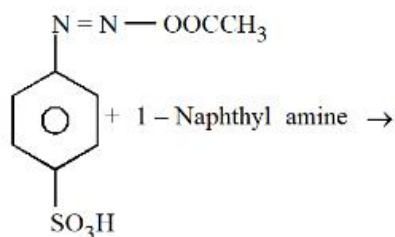

- Options**
- Blue
 - Red
 - Yellow
 - White

Question Type : MCQ

Question ID : 7155051580

Option 1 ID : 7155054760

Option 2 ID : 7155054759

Option 3 ID : 7155054757

Option 4 ID : 7155054758

Status : Not Answered

Chosen Option : --

Q.51 Sum of π – bonds present in peroxodisulphuric acid and pyrosulphuric acid is _____

Given 4
Answer :

Question Type : SA
Question ID : 7155051588
Status : Answered

Q.52 The number of units, which are used to express concentration of solutions from the following is

Mass percent, Mole, Mole fraction, Molarity, ppm, Molality

Given 4
Answer :

Question Type : SA
Question ID : 7155051581
Status : Answered

Q.53 Maximum number of isomeric monochloro derivatives which can be obtained from 2,2,5,5-tetramethylhexane by chlorination is _____

Given --
Answer :

Question Type : SA
Question ID : 7155051590
Status : Not Answered

Q.54 Following figure shows spectrum of an ideal black body at four different temperatures. The number of **correct** statement/s from the following is _____

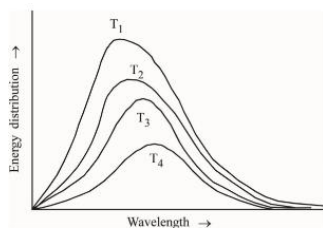

- A. $T_4 > T_3 > T_2 > T_1$
 B. The black body consists of particles performing simple harmonic motion.
 C. The peak of the spectrum shifts to shorter wavelength as temperature increases.
 D. $\frac{T_1}{\nu_1} = \frac{T_2}{\nu_2} = \frac{T_3}{\nu_3} \neq \text{constant}$
 E. The given spectrum could be explained using quantisation of energy.

Given --
Answer :

Question Type : SA
Question ID : 7155051582
Status : Not Answered

Q.55 One mole of an ideal monoatomic gas is subjected to changes as shown in the graph. The magnitude of the work done (by the system or on the system) is _____ J (nearest integer)

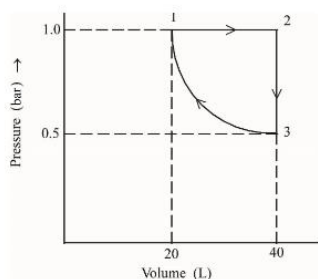

Given : $\log 2 = 0.3$
 $\ln 10 = 2.3$

Given --
 Answer :

Question Type : SA
 Question ID : 7155051584
 Status : Not Answered

Q.56 Total number of tripeptides possible by mixing of valine and proline is _____

Given --
 Answer :

Question Type : SA
 Question ID : 7155051589
 Status : Not Answered

Q.57 The total pressure observed by mixing two liquids A and B is 350 mm Hg when their mole fractions are 0.7 and 0.3 respectively. The total pressure becomes 410 mm Hg if the mole fractions are changed to 0.2 and 0.8 respectively for A and B. The vapour pressure of pure A is _____ mm Hg. (Nearest integer)
 Consider the liquids and solutions behave ideally.

Given **314**
 Answer :

Question Type : SA
 Question ID : 7155051585
 Status : Answered

Q.58 If the pKa of lactic acid is 5, then the pH of 0.005 M calcium lactate solution at 25° C is _____ $\times 10^{-1}$ (Nearest integer)

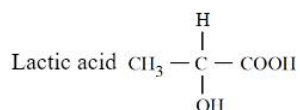

Given --
 Answer :

Question Type : SA
 Question ID : 7155051586
 Status : Not Answered

Q.59 The number of statement/s which are the characteristics of physisorption is _____

- A. It is highly specific in nature
- B. Enthalpy of adsorption is high
- C. It decreases with increase in temperature
- D. It results into unimolecular layer
- E. No activation energy is needed

Given --
Answer :

Question Type : SA
Question ID : 7155051587
Status : Not Answered

Q.60 The number of statement/s, which are **correct** with respect to the compression of carbon dioxide from point (a) in the Andrews isotherm from the following is _____

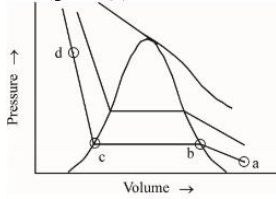

- A. Carbon dioxide remains as a gas upto point (b)
- B. Liquid carbon dioxide appears at point (c)
- C. Liquid and gaseous carbon dioxide coexist between points (b) and (c)
- D. As the volume decreases from (b) to (c), the amount of liquid decreases

Given --
Answer :

Question Type : SA
Question ID : 7155051583
Status : Not Answered

Section : Mathematics Section A

Q.61 The equations of the sides AB and AC of a triangle ABC are $(\lambda + 1)x + \lambda y = 4$ and $\lambda x + (1 - \lambda)y + \lambda = 0$ respectively. Its vertex A is on the y - axis and its orthocentre is (1,2). The length of the tangent from the point C to the part of the parabola $y^2 = 6x$ in the first quadrant is :

- Options
1. 4
 2. 2
 3. $2\sqrt{2}$
 4. $\sqrt{6}$

Question Type : MCQ
Question ID : 7155051605
Option 1 ID : 7155054830
Option 2 ID : 7155054827
Option 3 ID : 7155054828
Option 4 ID : 7155054829
Status : Not Answered
Chosen Option : --

Q.62 Let p and q be two statements. Then $\sim(p \wedge (p \Rightarrow \sim q))$ is equivalent to

- Options
1. $p \vee ((\sim p) \wedge q)$
 2. $(\sim p) \vee q$
 3. $p \vee (p \wedge q)$
 4. $p \vee (p \wedge (\sim q))$

Question Type : MCQ

Question ID : 7155051610

Option 1 ID : 7155054849

Option 2 ID : 7155054848

Option 3 ID : 7155054847

Option 4 ID : 7155054850

Status : Answered

Chosen Option : 2

Q.63 Let $y = y(x)$ be the solution of the differential equation $(x^2 - 3y^2) dx + 3xy dy = 0$, $y(1) = 1$.

Then $6y^2(e)$ is equal to

- Options
1. $\frac{3}{2}e^2$
 2. e^2
 3. $2e^2$
 4. $3e^2$

Question Type : MCQ

Question ID : 7155051603

Option 1 ID : 7155054820

Option 2 ID : 7155054819

Option 3 ID : 7155054821

Option 4 ID : 7155054822

Status : Not Answered

Chosen Option : --

Q.64 The number of real solutions of the equation $3\left(x^2 + \frac{1}{x^2}\right) - 2\left(x + \frac{1}{x}\right) + 5 = 0$, is

- Options
1. 3
 2. 4
 3. 0
 4. 2

Question Type : MCQ

Question ID : 7155051592

Option 1 ID : 7155054777

Option 2 ID : 7155054778

Option 3 ID : 7155054775

Option 4 ID : 7155054776

Status : Answered

Chosen Option : 3

Q.65 If $f(x) = \frac{2^{2x}}{2^{2x} + 2}$, $x \in \mathbb{R}$, then $f\left(\frac{1}{2023}\right) + f\left(\frac{2}{2023}\right) + \dots + f\left(\frac{2022}{2023}\right)$ is equal to

- Options**
1. 2010
 2. 2011
 3. 1011
 4. 1010

Question Type : **MCQ**

Question ID : **7155051591**

Option 1 ID : **7155054773**

Option 2 ID : **7155054774**

Option 3 ID : **7155054772**

Option 4 ID : **7155054771**

Status : **Not Answered**

Chosen Option : --

Q.66 If the system of equations

$$x + 2y + 3z = 3$$

$$4x + 3y - 4z = 4$$

$$8x + 4y - \lambda z = 9 + \mu$$

has infinitely many solutions, then the ordered pair (λ, μ) is equal to :

- Options**
1. $\left(-\frac{72}{5}, -\frac{21}{5}\right)$
 2. $\left(-\frac{72}{5}, \frac{21}{5}\right)$
 3. $\left(\frac{72}{5}, \frac{21}{5}\right)$
 4. $\left(\frac{72}{5}, -\frac{21}{5}\right)$

Question Type : **MCQ**

Question ID : **7155051594**

Option 1 ID : **7155054786**

Option 2 ID : **7155054784**

Option 3 ID : **7155054783**

Option 4 ID : **7155054785**

Status : **Answered**

Chosen Option : **4**

Q.67 The locus of the mid points of the chords of the circle $C_1 : (x-4)^2 + (y-5)^2 = 4$ which subtend an angle θ_i at the centre of the circle C_1 , is a circle of radius r_i . If $\theta_1 = \frac{\pi}{3}$, $\theta_3 = \frac{2\pi}{3}$ and

$r_1^2 = r_2^2 + r_3^2$, then θ_2 is equal to

- Options**
1. $\frac{\pi}{4}$
 2. $\frac{\pi}{2}$
 3. $\frac{3\pi}{4}$
 4. $\frac{\pi}{6}$

Question Type : MCQ

Question ID : 7155051604

Option 1 ID : 7155054825

Option 2 ID : 7155054823

Option 3 ID : 7155054826

Option 4 ID : 7155054824

Status : Not Answered

Chosen Option : --

Q.68 Let the plane containing the line of intersection of the planes $P_1 : x + (\lambda + 4)y + z = 1$ and $P_2 : 2x + y + z = 2$ pass through the points $(0, 1, 0)$ and $(1, 0, 1)$. Then the distance of the point $(2\lambda, \lambda, -\lambda)$ from the plane P_2 is

- Options**
1. $2\sqrt{6}$
 2. $5\sqrt{6}$
 3. $3\sqrt{6}$
 4. $4\sqrt{6}$

Question Type : MCQ

Question ID : 7155051606

Option 1 ID : 7155054831

Option 2 ID : 7155054834

Option 3 ID : 7155054832

Option 4 ID : 7155054833

Status : Not Answered

Chosen Option : --

Q.69 Let the six numbers $a_1, a_2, a_3, a_4, a_5, a_6$, be in A.P. and $a_1 + a_3 = 10$. If the mean of these six numbers is $\frac{19}{2}$ and their variance is σ^2 , then $8\sigma^2$ is equal to :

- Options**
1. 200
 2. 210
 3. 220
 4. 105

Question Type : MCQ

Question ID : 7155051609

Option 1 ID : 7155054843

Option 2 ID : 7155054845

Option 3 ID : 7155054846

Option 4 ID : 7155054844

Status : Not Answered

Chosen Option : --

Q.70 The set of all values of a for which $\lim_{x \rightarrow a} ([x-5] - [2x+2]) = 0$,

where $[\alpha]$ denotes the greatest integer less than or equal to α is equal to

- Options
1. $(-7.5, -6.5]$
 2. $[-7.5, -6.5)$
 3. $[-7.5, -6.5]$
 4. $(-7.5, -6.5)$

Question Type : MCQ

Question ID : 7155051600

Option 1 ID : 7155054809

Option 2 ID : 7155054810

Option 3 ID : 7155054808

Option 4 ID : 7155054807

Status : Answered

Chosen Option : 3

Q.71 If $f(x) = x^3 - x^2 f'(1) + x f''(2) - f'''(3)$, $x \in \mathbb{R}$, then

- Options
1. $f(1) + f(2) + f(3) = f(0)$
 2. $f(3) - f(2) = f(1)$
 3. $3f(1) + f(2) = f(3)$
 4. $2f(0) - f(1) + f(3) = f(2)$

Question Type : MCQ

Question ID : 7155051601

Option 1 ID : 7155054814

Option 2 ID : 7155054812

Option 3 ID : 7155054811

Option 4 ID : 7155054813

Status : Not Answered

Chosen Option : --

Q.72 Let $f(x)$ be a function such that $f(x+y) = f(x) \cdot f(y)$ for all $x, y \in \mathbb{N}$. If $f(1) = 3$ and $\sum_{k=1}^n f(k) = 3279$, then the value of n is

- Options
1. 8
 2. 7
 3. 9
 4. 6

Question Type : MCQ

Question ID : 7155051599

Option 1 ID : 7155054804

Option 2 ID : 7155054805

Option 3 ID : 7155054806

Option 4 ID : 7155054803

Status : Answered

Chosen Option : 2

Q.73

The value of $\left(\frac{1 + \sin \frac{2\pi}{9} + i \cos \frac{2\pi}{9}}{1 + \sin \frac{2\pi}{9} - i \cos \frac{2\pi}{9}} \right)^3$ is

Options

1. $\frac{1}{2}(1 - i\sqrt{3})$
2. $-\frac{1}{2}(\sqrt{3} - i)$
3. $-\frac{1}{2}(1 - i\sqrt{3})$
4. $\frac{1}{2}(\sqrt{3} + i)$

Question Type : MCQ

Question ID : 7155051593

Option 1 ID : 7155054781

Option 2 ID : 7155054779

Option 3 ID : 7155054782

Option 4 ID : 7155054780

Status : Not Answered

Chosen Option : --

Q.74 The number of integers, greater than 7000 that can be formed, using the digits 3,5,6,7,8 without repetition, is

Options 1. 48

2. 168

3. 220

4. 120

Question Type : MCQ

Question ID : 7155051597

Option 1 ID : 7155054795

Option 2 ID : 7155054796

Option 3 ID : 7155054798

Option 4 ID : 7155054797

Status : Answered

Chosen Option : 2

Q.75 $\int_{\frac{3\sqrt{2}}{4}}^{\frac{3\sqrt{3}}{4}} \frac{48}{\sqrt{9-4x^2}} dx$ is equal to

- Options
1. $\frac{\pi}{6}$
 2. $\frac{\pi}{3}$
 3. 2π
 4. $\frac{\pi}{2}$

Question Type : MCQ

Question ID : 7155051602

Option 1 ID : 7155054817

Option 2 ID : 7155054816

Option 3 ID : 7155054815

Option 4 ID : 7155054818

Status : Answered

Chosen Option : 3

Q.76 Let $\vec{\alpha} = 4\hat{i} + 3\hat{j} + 5\hat{k}$ and $\vec{\beta} = \hat{i} + 2\hat{j} - 4\hat{k}$. Let $\vec{\beta}_1$ be parallel to $\vec{\alpha}$ and $\vec{\beta}_2$ be perpendicular to $\vec{\alpha}$. If $\vec{\beta} = \vec{\beta}_1 + \vec{\beta}_2$, then the value of $5\vec{\beta}_2 \cdot (\hat{i} + \hat{j} + \hat{k})$ is

- Options
1. 6
 2. 9
 3. 11
 4. 7

Question Type : MCQ

Question ID : 7155051608

Option 1 ID : 7155054839

Option 2 ID : 7155054841

Option 3 ID : 7155054842

Option 4 ID : 7155054840

Status : Not Answered

Chosen Option : --

Q.77 Let A be a 3×3 matrix such that $|\text{adj}(\text{adj}(\text{adj} A))| = 12^4$. Then $|A^{-1} \text{adj} A|$ is equal to

- Options
1. 12
 2. 1
 3. $\sqrt{6}$
 4. $2\sqrt{3}$

Question Type : MCQ

Question ID : 7155051595

Option 1 ID : 7155054787

Option 2 ID : 7155054788

Option 3 ID : 7155054790

Option 4 ID : 7155054789

Status : Not Answered

Chosen Option : --

Q.78 If the foot of the perpendicular drawn from $(1, 9, 7)$ to the line passing through the point $(3, 2, 1)$ and parallel to the planes $x + 2y + z = 0$ and $3y - z = 3$ is (α, β, γ) , then $\alpha + \beta + \gamma$ is equal to

- Options 1. 5
2. 3
3. 1
4. -1

Question Type : MCQ

Question ID : 7155051607

Option 1 ID : 7155054836

Option 2 ID : 7155054835

Option 3 ID : 7155054837

Option 4 ID : 7155054838

Status : Not Answered

Chosen Option : --

Q.79 The number of square matrices of order 5 with entries from the set $\{0, 1\}$, such that the sum of all the elements in each row is 1 and the sum of all the elements in each column is also 1, is

- Options 1. 225
2. 125
3. 150
4. 120

Question Type : MCQ

Question ID : 7155051596

Option 1 ID : 7155054791

Option 2 ID : 7155054793

Option 3 ID : 7155054792

Option 4 ID : 7155054794

Status : Not Answered

Chosen Option : --

Q.80 If $({}^{30}C_1)^2 + 2({}^{30}C_2)^2 + 3({}^{30}C_3)^2 + \dots + 30({}^{30}C_{30})^2 = \frac{\alpha 60!}{(30!)^2}$ then α is equal to :

- Options 1. 60
2. 15
3. 10
4. 30

Question Type : MCQ

Question ID : 7155051598

Option 1 ID : 7155054802

Option 2 ID : 7155054800

Option 3 ID : 7155054799

Option 4 ID : 7155054801

Status : Not Answered

Chosen Option : --

Section : Mathematics Section B

Q.81 If $\frac{1^3 + 2^3 + 3^3 + \dots \text{ up to } n \text{ terms}}{1 \cdot 3 + 2 \cdot 5 + 3 \cdot 7 + \dots \text{ up to } n \text{ terms}} = \frac{9}{5}$, then the value of n is

Given --
Answer :

Question Type : SA

Question ID : 7155051613

Status : Not Answered

Q.82 Let f be a differentiable function defined on $\left[0, \frac{\pi}{2}\right]$ such that $f(x) > 0$ and

$$f(x) + \int_0^x f(t) \sqrt{1 - (\log_e f(t))^2} dt = e, \forall x \in \left[0, \frac{\pi}{2}\right]. \text{ Then } \left(6 \log_e f\left(\frac{\pi}{6}\right)\right)^2 \text{ is equal to } \underline{\hspace{2cm}}.$$

Given --
Answer :

Question Type : SA
Question ID : 7155051615
Status : Not Answered

Q.83 The equations of the sides AB, BC and CA of a triangle ABC are : $2x + y = 0$, $x + py = 21a$, ($a \neq 0$) and $x - y = 3$ respectively. Let P(2, a) be the centroid of ΔABC . Then $(BC)^2$ is equal to

Given --
Answer :

Question Type : SA
Question ID : 7155051619
Status : Not Answered

Q.84 If the shortest between the lines

$$\frac{x + \sqrt{6}}{2} = \frac{y - \sqrt{6}}{3} = \frac{z - \sqrt{6}}{4} \text{ and } \frac{x - \lambda}{3} = \frac{y - 2\sqrt{6}}{4} = \frac{z + 2\sqrt{6}}{5}$$

is 6, then the square of sum of all possible values of λ is

Given --
Answer :

Question Type : SA
Question ID : 7155051620
Status : Not Answered

Q.85 Let $S = \{\theta \in [0, 2\pi) : \tan(\pi \cos \theta) + \tan(\pi \sin \theta) = 0\}$.

Then $\sum_{\theta \in S} \sin^2\left(\theta + \frac{\pi}{4}\right)$ is equal to _____.

Given --
Answer :

Question Type : SA
Question ID : 7155051618
Status : Not Answered

Q.86 The minimum number of elements that must be added to the relation $R = \{(a, b), (b, c), (b, d)\}$ on the set $\{a, b, c, d\}$ so that it is an equivalence relation, is _____.

Given 9
Answer :

Question Type : SA
Question ID : 7155051611
Status : Answered

Q.87 Three urns A, B and C contain 4 red, 6 black; 5 red, 5 black; and λ red, 4 black balls respectively. One of the urns is selected at random and a ball is drawn. If the ball drawn is red and the probability that it is drawn from urn C is 0.4 then the square of the length of the side of the largest equilateral triangle, inscribed in the parabola $y^2 = \lambda x$ with one vertex at the vertex of the parabola, is

Given --
Answer :

Question Type : SA
Question ID : 7155051617
Status : Not Answered

Q.88 Let $\vec{a} = \hat{i} + 2\hat{j} + \lambda\hat{k}$, $\vec{b} = 3\hat{i} - 5\hat{j} - \lambda\hat{k}$, $\vec{a} \cdot \vec{c} = 7$, $2\vec{b} \cdot \vec{c} + 43 = 0$, $\vec{a} \times \vec{c} = \vec{b} \times \vec{c}$. Then $|\vec{a} \cdot \vec{b}|$ is equal to

Given --
Answer :

Question Type : SA
Question ID : 7155051616
Status : Not Answered

Q.89 Let the sum of the coefficients of the first three terms in the expansion of $\left(x - \frac{3}{x^2}\right)^n$, $x \neq 0$, $n \in \mathbb{N}$, be 376. Then the coefficient of x^4 is _____.

Given --
Answer :

Question Type : SA
Question ID : 7155051612
Status : Not Answered

Q.90 If the area of the region bounded by the curves $y^2 - 2y = -x$, $x + y = 0$ is A, then $8A$ is equal to _____

Given --
Answer :

Question Type : SA
Question ID : 7155051614
Status : Not Answered